

# VXIpc™ 800 Series User Manual

September 1997 Edition  
Part Number 321744A-01

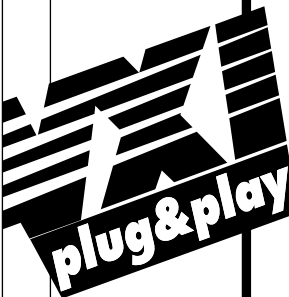



### **Internet Support**

support@natinst.com

E-mail: info@natinst.com

FTP Site: ftp.natinst.com

Web Address: <http://www.natinst.com>



### **Bulletin Board Support**

BBS United States: (512) 794-5422

BBS United Kingdom: 01635 551422

BBS France: 01 48 65 15 59



### **Fax-on-Demand Support**

(512) 418-1111

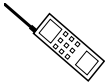

### **Telephone Support (U.S.)**

Tel: (512) 795-8248

Fax: (512) 794-5678

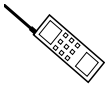

### **International Offices**

Australia 03 9879 5166, Austria 0662 45 79 90 0, Belgium 02 757 00 20, Brazil 011 288 3336,  
Canada (Ontario) 905 785 0085, Canada (Québec) 514 694 8521, Denmark 45 76 26 00,  
Finland 09 725 725 11, France 01 48 14 24 24, Germany 089 741 31 30,  
Hong Kong 2645 3186, Israel 03 6120092, Italy 02 413091, Japan 03 5472 2970,  
Korea 02 596 7456, Mexico 5 520 2635, Netherlands 0348 433466, Norway 32 84 84 00,  
Singapore 2265886, Spain 91 640 0085, Sweden 08 730 49 70, Switzerland 056 200 51 51,  
Taiwan 02 377 1200, United Kingdom 01635 523545

### **National Instruments Corporate Headquarters**

6504 Bridge Point Parkway Austin, TX 78730-5039 Tel: (512) 794-0100

# Important Information

---

## Warranty

The National Instruments VXIpc 800 Series embedded computers and accessories are warranted against defects in materials and workmanship for a period of one year from the date of shipment, as evidenced by receipts or other documentation. National Instruments will, at its option, repair or replace equipment that proves to be defective during the warranty period. This warranty includes parts and labor.

The media on which you receive National Instruments software are warranted not to fail to execute programming instructions, due to defects in materials and workmanship, for a period of 90 days from date of shipment, as evidenced by receipts or other documentation. National Instruments will, at its option, repair or replace software media that do not execute programming instructions if National Instruments receives notice of such defects during the warranty period. National Instruments does not warrant that the operation of the software shall be uninterrupted or error free.

A Return Material Authorization (RMA) number must be obtained from the factory and clearly marked on the outside of the package before any equipment will be accepted for warranty work. National Instruments will pay the shipping costs of returning to the owner parts which are covered by warranty.

National Instruments believes that the information in this manual is accurate. The document has been carefully reviewed for technical accuracy. In the event that technical or typographical errors exist, National Instruments reserves the right to make changes to subsequent editions of this document without prior notice to holders of this edition. The reader should consult National Instruments if errors are suspected. In no event shall National Instruments be liable for any damages arising out of or related to this document or the information contained in it.

EXCEPT AS SPECIFIED HEREIN, NATIONAL INSTRUMENTS MAKES NO WARRANTIES, EXPRESS OR IMPLIED, AND SPECIFICALLY DISCLAIMS ANY WARRANTY OF MERCHANTABILITY OR FITNESS FOR A PARTICULAR PURPOSE. CUSTOMER'S RIGHT TO RECOVER DAMAGES CAUSED BY FAULT OR NEGLIGENCE ON THE PART OF NATIONAL INSTRUMENTS SHALL BE LIMITED TO THE AMOUNT THEREFORE PAID BY THE CUSTOMER. NATIONAL INSTRUMENTS WILL NOT BE LIABLE FOR DAMAGES RESULTING FROM LOSS OF DATA, PROFITS, USE OF PRODUCTS, OR INCIDENTAL OR CONSEQUENTIAL DAMAGES, EVEN IF ADVISED OF THE POSSIBILITY THEREOF. This limitation of the liability of National Instruments will apply regardless of the form of action, whether in contract or tort, including negligence. Any action against National Instruments must be brought within one year after the cause of action accrues. National Instruments shall not be liable for any delay in performance due to causes beyond its reasonable control. The warranty provided herein does not cover damages, defects, malfunctions, or service failures caused by owner's failure to follow the National Instruments installation, operation, or maintenance instructions; owner's modification of the product; owner's abuse, misuse, or negligent acts; and power failure or surges, fire, flood, accident, actions of third parties, or other events outside reasonable control.

## Copyright

Under the copyright laws, this publication may not be reproduced or transmitted in any form, electronic or mechanical, including photocopying, recording, storing in an information retrieval system, or translating, in whole or in part, without the prior written consent of National Instruments Corporation.

## Trademarks

CVI™, LabVIEW™, MANTIS™, MITE™, NI-488.2™, NI-VISA™, NI-VXI™, TNT™, and VXIpc™ are trademarks of National Instruments Corporation.

Product and company names listed are trademarks or trade names of their respective companies.

## WARNING REGARDING MEDICAL AND CLINICAL USE OF NATIONAL INSTRUMENTS PRODUCTS

National Instruments products are not designed with components and testing intended to ensure a level of reliability suitable for use in treatment and diagnosis of humans. Applications of National Instruments products involving medical or clinical treatment can create a potential for accidental injury caused by product failure, or by errors on the part of the user or application designer. Any use or application of National Instruments products for or involving medical or clinical treatment must be performed by properly trained and qualified medical personnel, and all traditional medical safeguards, equipment, and procedures that are appropriate in the particular situation to prevent serious injury or death should always continue to be used when National Instruments products are being used. National Instruments products are NOT intended to be a substitute for any form of established process, procedure, or equipment used to monitor or safeguard human health and safety in medical or clinical treatment.

# FCC/DOC Radio Frequency Interference Class A Compliance

---

This equipment generates and uses radio frequency energy and, if not installed and used in strict accordance with the instructions in this manual, may cause interference to radio and television reception. Classification requirements are the same for the Federal Communications Commission (FCC) and the Canadian Department of Communications (DOC). This equipment has been tested and found to comply with the following two regulatory agencies:

## Federal Communications Commission

This equipment has been tested and found to comply with the limits for a Class A digital device, pursuant to part 15 of the FCC Rules. These limits are designed to provide reasonable protection against harmful interference when the equipment is operated in a commercial environment. This equipment generates, uses, and can radiate radio frequency energy and, if not installed and used in accordance with the instruction manual, may cause harmful interference to radio communications. Operation of this equipment in a residential area is likely to cause harmful interference in which case the user will be required to correct the interference at his own expense.

**Notices to User:** *Changes or modifications not expressly approved by National Instruments could void the user's authority to operate the equipment under the FCC Rules.*

*This device complies with the FCC rules only if used with shielded interface cables of suitable quality and construction. National Instruments used such cables to test this device and provides them for sale to the user. The use of inferior or nonshielded interface cables could void the user's authority to operate the equipment under the FCC rules.*

If necessary, consult National Instruments or an experienced radio/television technician for additional suggestions. The following booklet prepared by the FCC may also be helpful: *Interference to Home Electronic Entertainment Equipment Handbook*. This booklet is available from the U.S. Government Printing Office, Washington, DC 20402.

## Canadian Department of Communications

This Class A digital apparatus meets all requirements of the Canadian Interference-Causing Equipment Regulations.

Cet appareil numérique de la classe A respecte toutes les exigences du Règlement sur le matériel brouilleur du Canada.



*Table  
of  
Contents*

---

## About This Manual

Organization of This Manual .....	ix
Conventions Used in This Manual .....	x
How to Use This Documentation Set .....	xi
Related Documentation .....	xii
Customer Communication .....	xii

## Chapter 1

### Introduction

Overview .....	1-1
Optional Equipment .....	1-3
Optional Software .....	1-3
Hardware Description .....	1-4
Slot 0 Functionality .....	1-4
Custom Application-Specific Interface Chips .....	1-5
Front Panel Features .....	1-6
Peripheral Expansion .....	1-7

## Chapter 2

### Functional Overview

VXIpc 800 Functional Description .....	2-1
--	-----

## Chapter 3

### VXIpc 800 Series Configuration and Installation

Default Settings .....	3-1
Configuring the VXIpc 800 Series .....	3-4
How to Remove the Metal Enclosure .....	3-4
VXIbus Slot 0/Non-Slot 0 .....	3-4
VXIbus CLK10 Routing .....	3-5
Trigger Input Termination .....	3-8
EEPROM .....	3-8
How to Fix an Invalid EEPROM Configuration .....	3-9
Installed System RAM .....	3-10

Configuring the PC.....	3-10
SCSI Termination .....	3-11
GPIB Interrupt Level .....	3-11
System CMOS.....	3-12
Parallel Port DMA Level .....	3-12
Ethernet Power-On Defaults .....	3-13
Installing the VXIpc 800 Series .....	3-13

## **Chapter 4**

### **BIOS**

Entering BIOS Setup .....	4-1
---------------------------	-----

## **Appendix A**

### **Specifications**

## **Appendix B**

### **VXIpc 800 Series System Resources**

## **Appendix C**

### **LED Indicators**

## **Appendix D**

### **Front Panel and Connectors**

## **Appendix E**

### **Modifying and Installing I/O Expansion Boards**

## **Appendix F**

### **Common Questions**

## **Appendix G**

### **Customer Communication**

## **Glossary**

# Index

## Figures

Figure 1-1.	VXIpc-850 Embedded Computer .....	1-1
Figure 1-2.	VXIpc-860 Embedded Computer .....	1-2
Figure 2-1.	VXIpc 800 Series Block Diagram .....	2-2
Figure 3-1.	VXIpc 800 Series Parts Locator Diagram .....	3-2
Figure 3-2.	VXIbus Slot Configuration .....	3-5
Figure 3-3.	VXIbus CLK10 Routing .....	3-6
Figure 3-4.	SMB CLK10 Direction .....	3-6
Figure 3-5.	SMB CLK10 Termination .....	3-7
Figure 3-6.	SMB CLK10 Polarity .....	3-7
Figure 3-7.	SMB Trigger Input Termination .....	3-8
Figure 3-8.	Power-On Self Configuration Status .....	3-8
Figure 3-9.	EEPROM Configuration .....	3-9
Figure 3-10.	SCSI Termination .....	3-11
Figure 3-11.	GPIB Interrupt Level .....	3-11
Figure 3-12.	System CMOS .....	3-12
Figure 3-13.	Parallel Port DMA Channel .....	3-12
Figure 3-14.	Ethernet Power-On Defaults .....	3-13
Figure D-1.	VXIpc-800 Front Panel Layout and Dimensions .....	D-2
Figure D-2.	Keyboard and Mouse Connectors Location and Pinout .....	D-3
Figure D-3.	VGA Connector Location and Pinout .....	D-4
Figure D-4.	Ethernet Connector Location and Pinout .....	D-5
Figure D-5.	COM1 and COM2 Connectors Location and Pinout .....	D-7
Figure D-6.	Parallel Port Connector Location and Pinout .....	D-8
Figure D-7.	SCSI Connector Location and Pinout (SCSI II) .....	D-10
Figure D-8.	GPIB Connector Location and Pinout .....	D-12
Figure D-9.	SMB Connectors Location and Pinout .....	D-14
Figure D-10.	Speaker Connection Location .....	D-15
Figure D-11.	VXIbus Connectors Location and Pinout .....	D-17
Figure E-1.	I/O Board Dimensions for VXIpc-850 Expansion Slot .....	E-1
Figure E-2.	Component Height Restrictions for PCI Plug-In Boards Used with the VXIpc-850 E-2	
Figure E-3.	Length Restrictions for ISA Plug-In Boards Used with the VXIpc-850 when SIMMs Taller than 0.85 in. are Used .....	E-3
Figure E-4.	I/O Board Dimensions for VXIpc-860 Expansion Slot .....	E-4

Figure E-5.	Length Restrictions for PCI Plug-In Boards Used with the VXIpc-860.....	E-5
Figure E-6.	Length Restrictions for ISA Plug-In Boards Used with the VXIpc-860 when SIMMs Taller than 0.85 in. are Used .....	E-6
Figure E-7.	PCI Board and ISA Board Installed in a VXIpc-800 .....	E-8
Figure E-8.	Side View of PCI Board with Expansion Bracket .....	E-8
Figure E-9.	Front View of PCI Board Expansion Bracket .....	E-9
Figure E-10.	Side View of ISA Board with Expansion Bracket .....	E-10
Figure E-11.	Front View of ISA Board Expansion Bracket.....	E-11

## Tables

Table 1-1.	VXIpc 800 Series Peripherals Overview.....	1-8
Table 3-1.	VXIpc 800 Series Hardware Default Settings.....	3-3
Table B-1.	VXIpc 800 Series ISA Interrupt Resource Allocations.....	B-1
Table B-2.	VXIpc 800 Series DMA Channel Resource Allocations .....	B-2
Table B-3.	VXIpc 800 Series I/O Address Map.....	B-3
Table C-1.	LEDs and System Startup Status.....	C-2
Table D-1.	Keyboard and Mouse Connector Signals .....	D-3
Table D-2.	VGA Connector Signals.....	D-4
Table D-3.	Ethernet Connector Signals .....	D-6
Table D-4.	COM1 and COM2 Connector Signals.....	D-7
Table D-5.	Parallel Port Connector Signals.....	D-9
Table D-6.	SCSI Connector Signals .....	D-11
Table D-7.	GPIB Connector Signals .....	D-13
Table D-8.	SMB Connector Signals .....	D-14
Table D-9.	Signal Characteristics for SMB and Speaker Connections .....	D-16
Table D-10.	VXIbus P2 Connector Signals.....	D-17
Table D-11.	VXIbus P1 Connector Signals.....	D-19



---

This manual contains instructions for installing and configuring the National Instruments VXIpc 800 Series embedded computer kit. The VXIpc 800 Series includes all the models of the VXIpc-800 embedded computers.

## Organization of This Manual

---

This manual is organized as follows:

- Chapter 1, *Introduction*, describes the VXIpc 800 Series of embedded VXI computers, lists what you need to get started, describes the hardware, and lists optional equipment and software.
- Chapter 2, *Functional Overview*, contains functional descriptions of each major logic block on the VXIpc 800 Series embedded computers.
- Chapter 3, *VXIpc 800 Series Configuration and Installation*, contains the instructions to configure and install the VXIpc 800 Series embedded computer.
- Chapter 4, *BIOS*, contains information on BIOS, the low-level interface between the hardware and PC software that configures and tests your hardware at boot up.
- Appendix A, *Specifications*, describes the environmental, electrical, and mechanical specifications of the VXIpc 800 Series embedded computer.
- Appendix B, *VXIpc 800 Series System Resources*, describes what system resources are available on the VXIpc 800 Series and where they are allocated.
- Appendix C, *LED Indicators*, describes how to read the LEDs on the front panel to interpret the status of the VXIpc 800 Series.
- Appendix D, *Front Panel and Connectors*, describes the front panel and connectors on the VXIpc 800 Series.

- Appendix E, *Modifying and Installing I/O Expansion Boards*, explains how to modify and install an I/O board in the VXIpc 800 Series.
- Appendix F, *Common Questions*, answers common questions you may have when using the VXIpc 800 Series.
- Appendix G, *Customer Communication*, contains forms you can use to request help from National Instruments or to comment on our products and manuals.
- The *Glossary* contains an alphabetical list and description of terms used in this manual, including abbreviations, acronyms, metric prefixes, mnemonics, and symbols.
- The *Index* contains an alphabetical list of key terms and topics used in this manual, including the page where you can find each one.

## Conventions Used in This Manual

---

The following conventions are used in this manual:

< >

Angle brackets enclose the name of a key on the keyboard (for example, <Option>).

-

A hyphen between two or more key names enclosed in angle brackets denotes that you should simultaneously press the named keys—for example, <Control-Alt-Delete>.

◆

The ◆ symbol indicates that the text following it applies only to a specific product, a specific operating system, or a specific software version.



This icon to the left of bold italicized text denotes a note, which alerts you to important information.



This icon to the left of bold italicized text denotes a caution, which advises you of precautions to take to avoid injury, data loss, or a system crash.



This icon to the left of bold italicized text denotes a warning, which advises you of precautions to take to avoid being electrically shocked.

**bold**

Bold text denotes the names of menus, menu items, dialog box buttons or options, or LEDs.

***bold italic***

Bold italic text denotes a note, caution, or warning.

**bold monospace**

Bold text in this font denotes the messages and responses that the computer automatically prints to the screen.

<i>italic</i>	Italic text denotes emphasis, a cross reference, or an introduction to a key concept. This font also denotes text from which you supply the appropriate word or value, as in Windows 3.x.
monospace	Text in this font denotes text or characters that are to be literally input from the keyboard, sections of code, programming examples, and syntax examples. This font is also used for the proper names of disk drives, paths, directories, device names, functions, variables, filenames, and extensions.
VXIpc 800 Series	The terms <i>VXIpc 800 Series</i> and <i>VXIpc-800</i> refer to a series of C-size, dual-slot VXI controllers. Currently, this series consists of the VXIpc-850 and VXIpc-860, with various processors and in different speeds.
	Abbreviations, acronyms, metric prefixes, mnemonics, symbols, and terms are listed in the <i>Glossary</i> .

## How to Use This Documentation Set

---

Begin by reading the *Getting Started with Your VXIpc 800/700 Series* manual for basic instructions for setting up the hardware and software. This is a brief quick start manual that describes how to get started with your kit using the default hardware and software settings, and how to configure and use the NI-VXI software. Refer to the following manuals for more information about the hardware or software.

This manual, the *VXIpc 800 Series User Manual*, contains more details about changing the installation or configuration from the defaults, and using the hardware.

When you are familiar with the material in these manuals, you can begin to use the *NI-VXI User Manual*. This manual presents the concepts of VXI and prepares you for detailed explanations of the NI-VXI functions. Study the descriptions of each function given in the *NI-VXI Programmer Reference Manual* to fully understand the purpose and syntax of each function. These two manuals are available in the `c:\NIVXI\Manuals` directory under the names `NI-VXIUsersMan.pdf` and `NI-VXIProgrammerMan.pdf`, respectively. Use the Acrobat Reader 3.0 program to open and view these files. You can also access the NI-VXI online help for Windows 95/NT/3.1 in the NIVXI folder.

Refer to the *NI-VISA User Manual* to learn about VISA and how to use it in your system. The NI-VISA online help describes the attributes, events, and operations you can use in NI-VISA. The user manual is available in the `c:\VXIpc\os\NIvisa\Manuals` directory (where *os* is either `win95` or `winNT`) under the name `NI-VISAUsersMan.pdf`. Use the Acrobat Reader program, Version 3 or later, to open this file.

## Related Documentation

---

The following documents contain information that you may find helpful as you read this manual:

- ANSI/IEEE Standard 1014-1987, *IEEE Standard for a Versatile Backplane Bus: VMEbus*
- ANSI/IEEE Standard 1155-1993, *IEEE VMEbus Extensions for Instrumentation: VXIbus*
- ANSI/VITA 1-1994, *VME64*
- VXI-6, *VXIbus Mainframe Extender Specification*, Rev. 1.0, VXIbus Consortium

## Customer Communication

---

National Instruments wants to receive your comments on our products and manuals. We are interested in the applications you develop with our products, and we want to help if you have problems with them. To make it easy for you to contact us, this manual contains comment and configuration forms for you to complete. These forms are in Appendix G, *Customer Communication*, at the end of this manual.

# Introduction

---

Chapter

1

This chapter describes the VXIpc 800 Series of embedded VXI computers, lists what you need to get started, describes the hardware, and lists optional equipment and software.

## Overview

---

Figure 1-1 shows a VXIpc-850 model with its cover removed.

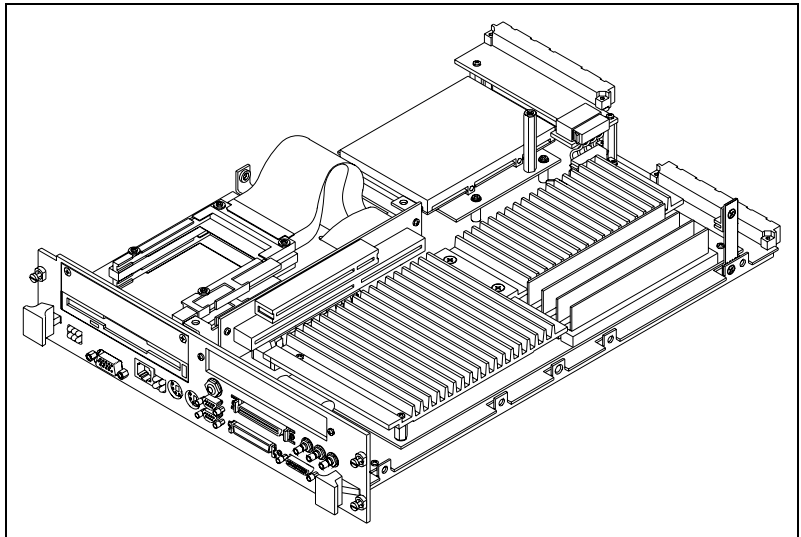

**Figure 1-1.** VXIpc-850 Embedded Computer

Figure 1-2 shows a VXIpc-860 model with its cover removed.

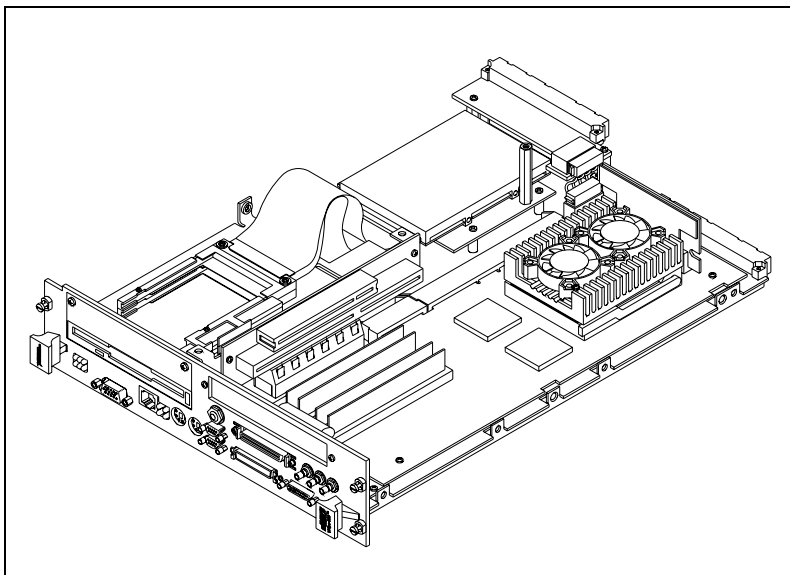

**Figure 1-2.** VXIpc-860 Embedded Computer

The VXIpc 800 Series controllers are C-size, embedded computers based on the Peripheral Component Interface (PCI) bus and Industry Standard Architecture (ISA). These computers are high-performance, easy-to-use platforms for controlling VXIbus systems, featuring complete VXI functionality through interactive utilities and C function calls. In addition, the VXIpc 800 Series has Ethernet capability plus an IEEE 488.2 interface that is compatible with the NI-488.2 architecture.

The VXIpc 800 Series is a custom computer that you install directly in two C-size slots of your VXIbus mainframe. An embedded computer can take full advantage of the VXI high-performance backplane capabilities and give you direct control of VXI registers, memory, interrupts, and triggers.

All models in the VXIpc 800 Series are fully *VXIplug&play* compliant and are compatible with PC-compatible software tools, the National Instruments LabVIEW and LabWindows™/CVI application software, and the NI-VXI, NI-VISA, and NI-488.2 bus interface software.

## Optional Equipment

---

You can contact National Instruments to order any of the following optional equipment:

- COM1/2 adapter cable
- Enhanced parallel port adapter cable
- Single-shielded 2 m GPIB cable
- Upgrades for the VXIpc 800 Series modular CPU card

## Optional Software

---

National Instruments has developed several software kits that you can use with the VXIpc 800 Series. The NI-VXI bus interface software for the VXIpc 800 includes a Resource Manager, an interactive VXI resource editor program, a comprehensive library of software routines for VXI/VME programming, and an interactive control program for interacting with VXI/VME. You can use this software to seamlessly program multiple-mainframe configurations and have software compatibility across a variety of VXI/VME controller platforms.

The NI-488.2 software kit gives you accessibility to the industry-standard NI-488.2 software for controlling external GPIB instruments through the GPIB port on the front panel of your VXIpc 800 Series. The GPIB interface on your VXIpc controller is fully compatible with the NI-488.2 driver for a variety of operating systems. Any software using NI-488.2 will run on the VXIpc 800.

You can also use the National Instruments LabVIEW and LabWindows/CVI application programs and instrument drivers to ease your programming task. These standardized programs match the modular virtual instrument capability of VXI and can reduce your VXI/VMEbus software development time. These programs are fully *VXIplug&play* compliant and feature extensive libraries of VXI instrument drivers written to take full advantage of direct VXI control.

LabVIEW is a complete programming environment that departs from the sequential nature of traditional programming languages and features a graphical programming environment.

LabWindows/CVI is an interactive C development environment for building test and measurement and instrument control systems. It includes interactive code-generation tools and a graphical editor for building custom user interfaces.

LabVIEW and LabWindows/CVI include all the tools needed for instrument control, data acquisition, analysis, and presentation. When you order the LabVIEW Full Development System for Windows or the LabWindows/CVI Full Development System for Windows, you also get more than 500 complete instrument drivers, which are modular, source-code programs that handle the communication with your instrument to speed your application development.

## Hardware Description

---

The VXIpc 800 Series controllers feature a modular, PCI-based local bus design that makes it easy to use interchangeable daughterboards to upgrade your controller to new microprocessors, without having to replace the motherboard or enclosure.

The VXIpc 800 Series currently consists of two models—the VXIpc-850 and the VXIpc-860—which vary in processors and speeds.

The CPU module and its memory sockets are easily accessible for you to install additional DRAM in the field:

- Up to 128 MB for the VXIpc-850
- Up to 256 MB for the VXIpc-860

The VXIpc 800 contains at least an 800 MB internal, enhanced IDE hard disk. For information on adding RAM by installing SIMMs, refer to Appendix A, *Specifications*.

## Slot 0 Functionality

You can use the VXIpc 800 Series computers to achieve full VXI Slot 0 control of your VXI system. You can also install the VXIpc 800 in another slot and use it in Non-Slot 0 mode. You do not have to change any switches or jumpers when moving between these two modes, as the VXIpc 800 can automatically detect whether it is installed in Slot 0 and it will automatically enable or disable the Slot 0 onboard circuitry.



## Custom Application-Specific Interface Chips

The VXIpc 800 Series uses the MITE and MANTIS custom ASICs to deliver high VXI performance, and can achieve more than 20 MB/s DMA block-mode data transfer rates across the VXI backplane.

The VXIpc 800 Series has the TNT4882C custom ASIC to give full GPIB control of external instruments via a front-panel connector. GPIB capability is fully compatible with IEEE 488.2 and the industry-standard NI-488.2 driver for a variety of operating systems.

The MITE custom ASIC is a sophisticated dual-channel DMA controller with standard interfaces for VXI and PCI. By using MITE DMA to transfer data and commands to and from devices, the MITE frees the computer's microprocessor to perform other tasks such as data analysis and presentation. In addition to DMA, the MITE incorporates the new VME64 MBLT (8-byte block transfers in which both the address bus and data bus are used to transfer data) directly into the ASIC to perform the fastest transfer operation to instruments. With the multiple windowing scheme of the MITE, you can easily access all of VXI address space.

The VXI trigger interface on the VXIpc 800 is based on the MANTIS custom ASIC. The VXIpc 800 front panel has two SMB trigger I/O connectors, which you can use to route any of the TTL trigger lines between the backplane and external devices. The MANTIS ASIC on the VXIpc 800 provides the complete VXI interface to the backplane connector in a single chip. The VXIpc 800 can respond to all VXI-defined protocols on all P2 TTL and ECL trigger lines at the same time. The MANTIS features an internal cross-matrix switching system for routing between lines as well as to and from the front panel and onboard clocks.

**Note:**

***The MANTIS ASIC contains the exact functionality of the TIC ASIC, which appeared on the VXIpc-486 Model 500 Series controllers. Any application that currently uses any of the TIC functionality, such as the crosspoint switch and counter/timers, can run on a controller containing the MANTIS ASIC without modification.***

## Front Panel Features

The VXIpc 800 has the following front-panel features:

- PCMCIA slots
  - The VXIpc 800 Series has one Type I/II and one Type I/II/III slot.
- One full-size expansion slot (on the VXIpc-850 only) that accepts either a PCI or a PC ISA (XT-height) plug-in board
- One half-length expansion slot (on the VXIpc-860 only) that accepts either a PCI or a PC ISA (XT-height) plug-in board
- Internal 3.5 in. floppy drive
- System reset push-button
- 13 front-panel connectors as listed below
  - Two RS-232 Serial
  - Extended Capabilities Parallel (ECP)
  - VGA Controller
  - IEEE 488.2
  - 10BaseT Ethernet
  - SCSI-2
  - External Clock
  - Trigger Output
  - Trigger Input
  - Audio Output
  - PS/2-Style Keyboard
  - PS/2-Style Mouse
- Six front-panel LEDs that show VXI and PC status
  - **SYSFAIL** LED indicates that the VMEbus SYSFAIL line is asserted.
  - **FAILED** LED indicates that the VXIpc 800 is driving the SYSFAIL signal.
  - **TEST** LED indicates that the VXIpc 800 is performing its self-tests or startup Resource Manager operations.
  - **ON LINE** LED indicates that the VXIpc 800 is performing or has completed its startup Resource Manager operations.

- **ACCESS** LED indicates when the VXIpc 800 MODID line is asserted or the VXIbus registers or shared memory are accessed by another bus master.
- **DRIVE** LED indicates when the internal hard drive is in use.
- Four front-panel LEDs that show Ethernet port status (VXIpc 800 Series only)
  - **RX** LED indicates that the VXIpc 800 Series is receiving data through its Ethernet port.
  - **TX** LED indicates that the VXIpc 800 Series is transmitting data through its Ethernet port.
  - **DSEL** LED indicates that the Ethernet circuitry is being accessed.
  - **LINK** LED reflects Ethernet link status.

## Peripheral Expansion

The VXIpc 800 uses the PCI local bus and ISA bus for peripheral expansion. The PCIbus is a 32-bit multimaster bus that achieves a top throughput of 132 MB/s and can handle numerous peripherals. The ISA bus is the legacy peripheral bus found on current and older PCs.

For information on installing and configuring these peripherals for use with the VXIpc 800, refer to the `c:\images\manuals` directory. The `drivers.txt` file explains how to install support for each peripheral. This directory also contains manufacturer's documentation for the video, PCMCIA, and SCSI peripherals. Also refer to the `readme` files for the most up-to-date information.

Table 1-1 lists the various peripherals and describes the external connector, its bus interface, and its function.

**Table 1-1.** VXIpc 800 Series Peripherals Overview

<b>Peripheral</b>	<b>External Connector</b>	<b>ISA or PCI</b>	<b>Function</b>
Video	15-pin DSUB (standard VGA)	PCI	High-resolution/ color support for a Super VGA monitor
IDE	None	PCI	Supports internal fast ATA-2 hard drive
Ethernet	RJ-45	ISA	10BaseT Ethernet connection
PCMCIA	Type I/II and Type I/II/III	PCI	Supports two independent PCMCIA slots
SCSI	36-pin SCSI-2	PCI	External SCSI-2 connection for hard drives, CD-ROM drives, and so on
GPIB	24-pin CHAMP	ISA	IEEE 488.2 interface compatible with the National Instruments AT-GPIB/TNT
VXI	Two 96-pin DIN (rear of board)	PCI	High-performance VXIbus interface
Serial	Serial Port (Mini DSUB)	ISA	16550 serial ports
Parallel	Parallel Port (IEEE 1284)	ISA	Extended capabilities

# Functional Overview

---

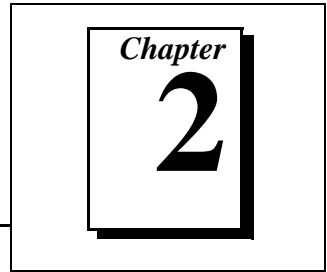

This chapter contains functional descriptions of each major logic block on the VXIpc 800 Series embedded computers.

## VXIpc 800 Functional Description

---

The VXIpc 800 is a modular PC in a VXIbus C-size form factor. It includes many high-performance peripherals that normally require add-in cards on desktop PCs. In addition, it has a VXIbus interface that is controlled from the PCI local bus, providing extremely high performance and reliability.

Figure 2-1 is a functional block diagram of the VXIpc 800 Series. Following the diagram is a description of each logic block shown.

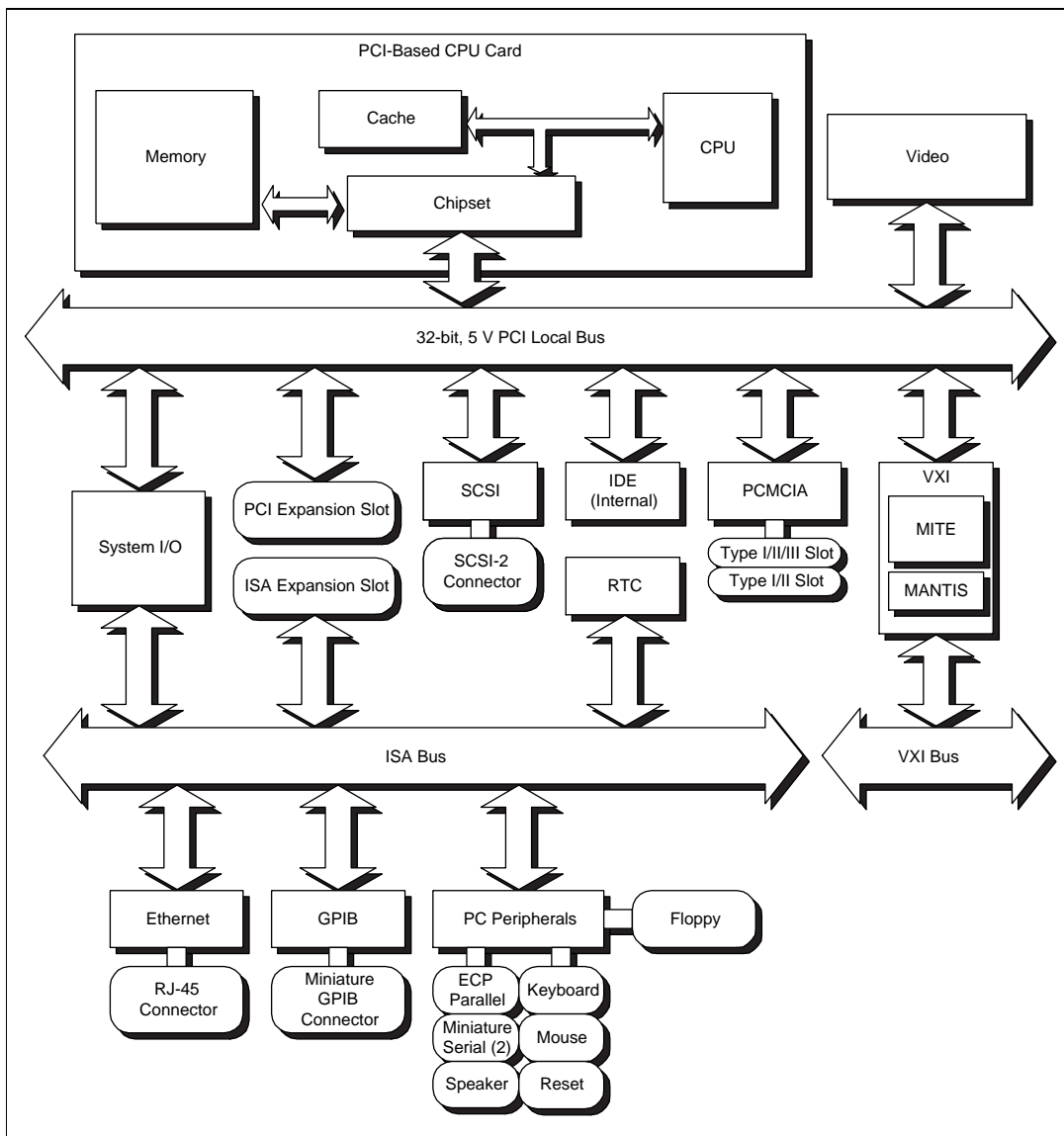

Figure 2-1. VXIpc 800 Series Block Diagram

The VXIpc 800 consists of the following logic blocks:

<b>Video</b>	The video circuitry is a plug-in PCI card that has a 64-bit data path to up to 4 MB of EDO DRAM.
<b>IDE</b>	This is dedicated PCI-IDE circuitry providing fast ATA-2 transfers to the internal hard drive.
<b>PCMCIA</b>	This is a dedicated PCI-PCMCIA interface that supports two independent PCMCIA cards. One socket can accommodate a Type I, II, or III card while the other accommodates a Type I or II card.
<b>VXI</b>	This is the PCI-VXIBus interface circuitry. The MITE is a National Instruments ASIC developed to efficiently manage data transfers between the VXIBus and the processor (via the PCI bus). The MANTIS ASIC (also developed by National Instruments) performs VXIBus arbitration and manages interrupts and triggers. Also part of the VXIBus interface are the SMB connectors, which you can use to route triggers and the CLK10 signal to or from the VXIBus.
<b>Ethernet</b>	This is an ISA-based Ethernet circuit on the VXIpc 800 Series. It uses an RJ-45 connector for access to an external Ethernet-based LAN.
<b>GPIB</b>	This logic block represents the IEEE 488.2 port on the VXIpc 800 Series. It uses the National Instruments TNT4882 ASIC for maximum performance as an ISA-based GPIB controller.
<b>PC Peripherals</b>	These blocks represent the other peripherals supplied by the VXIpc 800. The VXIpc 800 Series has PS/2 mouse and keyboard ports, two miniature serial ports, and ECP/EPP parallel port, speaker jack, reset button, and a 1.44 MB, 3.5 in. floppy drive.

<b>CPU Card</b>	The modular architecture of the VXIpc 800 Series contains a plug-in CPU card that can accommodate various Pentium/Pentium Pro-class processors. This card includes the CPU, chipset support that connects the CPU subsystem to the PCI bus, and the system cache and RAM.
<b>System I/O</b>	This block has the bridge between the PCI bus and the ISA bus. It also has PCI bus arbitration logic and integrates PC-specific hardware such as the DMA and interrupt controllers.
<b>PCI Expansion Slot</b>	This is a general-purpose PCI slot. It can accommodate any standard 5 V, 32-bit PCI card with a modified mounting bracket.
<b>ISA Expansion Slot</b>	This is a general-purpose ISA expansion slot. The VXIpc-860 can accommodate a half-length XT-size card, while the VXIpc-850 can accommodate a full-length XT-size card. However, the DRAM configuration may mechanically interfere with a full-length card. Refer to Appendix E, <i>Modifying and Installing I/O Expansion Boards</i> , for more information.
<b>SCSI</b>	The SCSI circuitry uses a PCI-SCSI bridge to provide a flexible SCSI-2 connection on the front panel, usable for such devices as external hard disks and CD-ROM drives.



# VXIpc 800 Series Configuration and Installation

---

Chapter

3

This chapter contains the instructions to configure and install the VXIpc 800 Series embedded computer. Unless otherwise noted, these instructions apply to all models in the VXIpc 800 Series, which currently consists of the VXIpc-850 and the VXIpc-860.



**Caution:** *Electrostatic discharge can damage several components on your VXIpc-800 module. To avoid such damage in handling the module, touch the antistatic plastic package to a metal part of your VXI chassis before removing the module from the package.*

## Default Settings

---

This section summarizes the hardware default settings for the VXIpc 800 Series for easy reference. The module is set at the factory for the most commonly used configuration.

Figure 3-1 shows the location and factory-default settings of most of the configuration switches and jumpers on the VXIpc 800 Series.

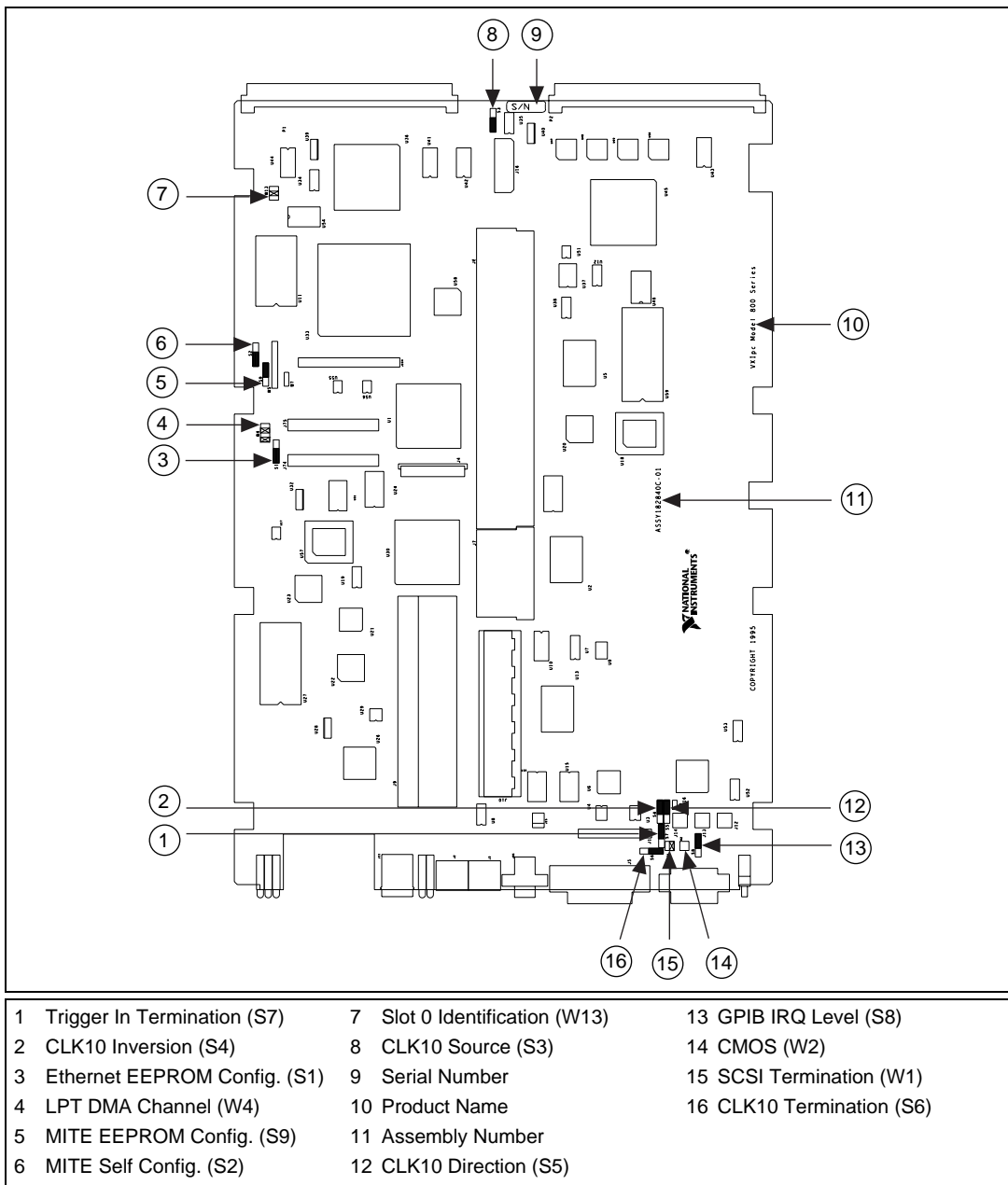

**Figure 3-1.** VXIpc 800 Series Parts Locator Diagram

Table 3-1 lists the factory-default settings and options for the onboard jumpers and switches.

**Table 3-1.** VXIpc 800 Series Hardware Default Settings

<b>Jumper/ Switch</b>	<b>Default Setting</b>	<b>Optional Setting</b>
W1	Supply SCSI termination power	Disable SCSI termination
W2	Normal CMOS operation	Clear CMOS
W4	LPT1 uses DMA Channel 1	LPT uses DMA Channel 3
W13	Enable automatic Slot 0 detection	Force Slot 0; Force Non-Slot 0
S1	Enable Ethernet EEPROM configuration	Disable Ethernet EEPROM configuration (uses default power on values)
S2	Enable MITE self-configuration	Disable MITE self-configuration
S3	Source CLK10 from onboard oscillator	Source CLK10 from SMB
S4	Non-inverted CLK10 output	Inverted CLK10 output
S5	Receive CLK10 input from SMB	Source CLK10 output to SMB
S6	No termination on CLK10 input	Terminate CLK10 input to 50 $\Omega$
S7	No termination on external trigger input	Terminate external trigger input to 50 $\Omega$
S8	GPIB uses IRQ11	GPIB uses IRQ5
S9	MITE user configuration	MITE factory configuration

## Configuring the VXIpc 800 Series

---

This section describes how to configure the following options on the VXIpc-800:

- VXIbus Slot 0/Non-Slot 0
- VXIbus CLK10 routing
- Trigger input termination
- EEPROM
- Installed system RAM

### How to Remove the Metal Enclosure

The VXIpc-800 is housed in a metal enclosure comprised of a top and bottom cover to improve EMC performance and to provide easy handling. You must remove the top cover to change many of the switch and jumper settings. You must also remove the top cover to change the amount of DRAM installed on the module.

Remove the top cover by removing the 12 screws that attach it to the module.

### VXIbus Slot 0/Non-Slot 0

The VXIpc-800 is configured at the factory to automatically detect if it is installed in Slot 0 of a VXIbus mainframe. With automatic Slot 0 detection, you can install the module into any VXIbus slot.

You can manually configure the VXIpc-800 for either Slot 0 or Non-Slot 0 operation by defeating the automatic-detection circuitry. Use the three-position jumper W13 to select automatic Slot 0 detection, Slot 0, or Non-Slot 0 operation. Figure 3-2 shows these three settings.



**Caution:** *Do not install a device configured for Slot 0 into another slot without first reconfiguring it to either Non-Slot 0 or automatic configuration. Neglecting to do this could result in damage to the device, the VXIbus backplane, or both.*

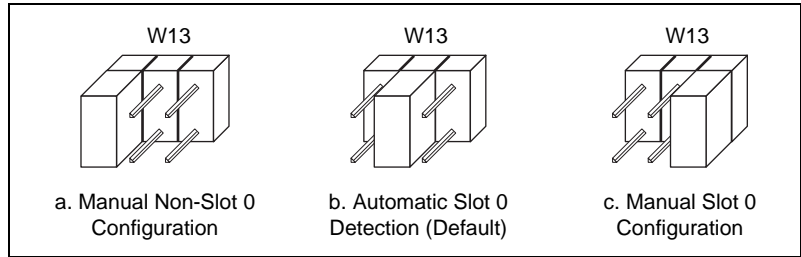

**Figure 3-2.** VXIbus Slot Configuration

When the VXIpc-800 is installed in Slot 0, it becomes the VXIbus System Controller. In this role, it has VXIbus Data Transfer Bus Arbiter circuitry that accepts bus requests on all four VXIbus request levels, prioritizes the requests, and grants the bus to the highest priority requester. As VXIbus System Controller, the VXIpc-800 also drives the 16 MHz VXIbus system clock by an onboard 16 MHz oscillator.

As required by the VXIbus specification, the VXIpc-800 drives the 10 MHz signal CLK10 on a differential ECL output when installed in Slot 0. When not installed in Slot 0, the VXIpc-800 only receives the CLK10 signal.

## VXIbus CLK10 Routing

When the VXIpc-800 is installed in Slot 0 of your mainframe, it supplies the VXIbus CLK10 signal. The VXIpc-800 can use two different sources to generate this signal: an onboard oscillator, or the external CLK SMB connector. Use switch S3 to select these options, as shown in Figure 3-3.

Notice that Figure 3-3b also shows switch S5. You must configure these switches as shown when using the corresponding CLK10 source setting of S3.

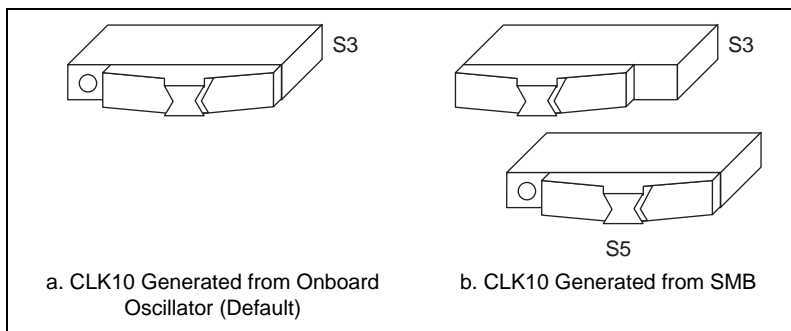

**Figure 3-3.** VXIbus CLK10 Routing

The VXIpc-800 can also be configured to drive the external CLK SMB signal from the VXIbus CLK10 signal. Switch S5 controls whether the VXIpc-800 drives or receives the external CLK SMB signal. If you change the S5 setting to drive CLK10 out the external CLK10 SMB connector (Figure 3-4b), do not set S3 to source CLK10 to the backplane from the SMB; instead use the setting shown in Figure 3-3a.

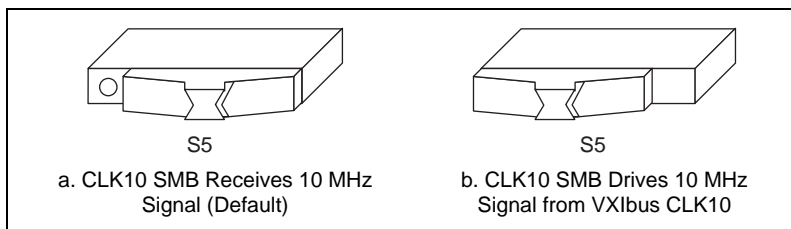

**Figure 3-4.** SMB CLK10 Direction

When switch S5 is set so that the VXIpc-800 receives the SMB CLK10 signal, you have the option to add a 50  $\Omega$  termination to the signal by setting switch S6. Switch S6 is unused—its setting does not matter—when S5 is configured to drive the external CLK SMB signal. Figure 3-5 shows the settings for switch S6.

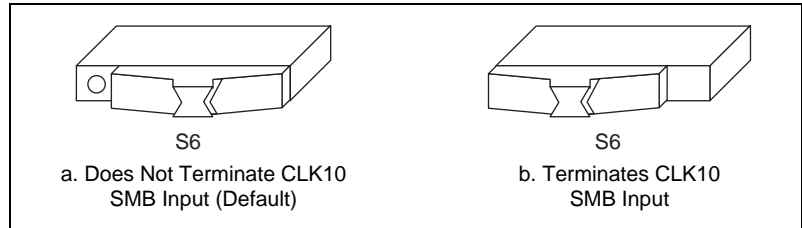

**Figure 3-5.** SMB CLK10 Termination

You can use an additional switch, S4, to control the polarity of the external CLK SMB signal when S5 is configured to drive it. S4 is unused—its setting does not matter—when S5 is configured to receive the external CLK SMB signal.

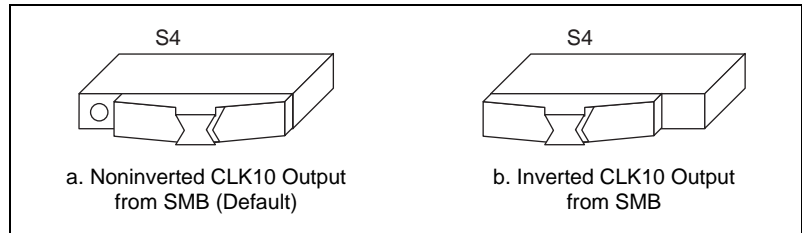

**Figure 3-6.** SMB CLK10 Polarity

## Trigger Input Termination

You can use switch S7 to terminate the external trigger input SMB with  $50\ \Omega$  to ground. Figure 3-7a shows the default setting for a non-terminated trigger input SMB. Use the setting of Figure 3-7b to terminate the trigger input SMB. Switch S7 is located above switches S4, S5, and S6, which have no effect on this configuration.

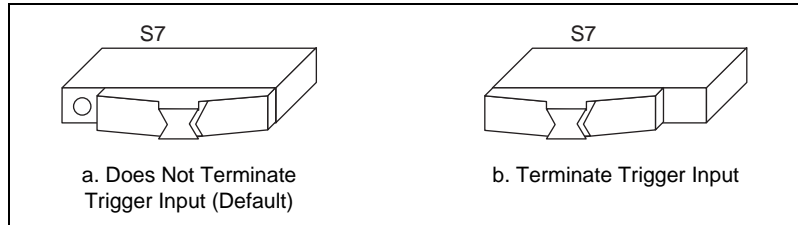

**Figure 3-7.** SMB Trigger Input Termination

## EEPROM

The VXIpc-800 has an onboard EEPROM, which stores default register values for the VXI circuitry. These values are loaded when you power up the computer. These values read from the EEPROM tell the PCI interface of the VXIbus registers so that the VXI interface is ready to respond to Resource Manager accesses within the required 5 s of SYSRST\* deasserting. You can use switch S2 to disable this power-on self-configuration (POSC) circuit. Although this makes the VXI circuitry unusable, it is sometimes helpful in debugging address and interrupt conflicts with add-in boards. In general, however, you should leave switch S2 in its factory-default setting. Figure 3-8 shows the possible configurations for S2.

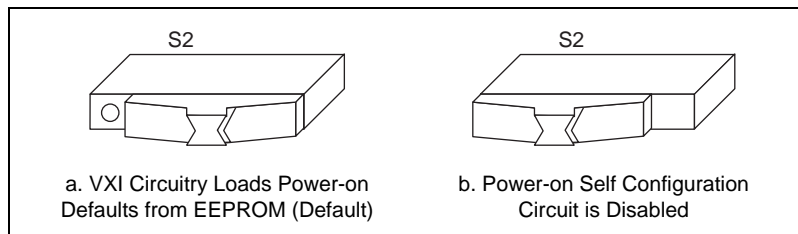
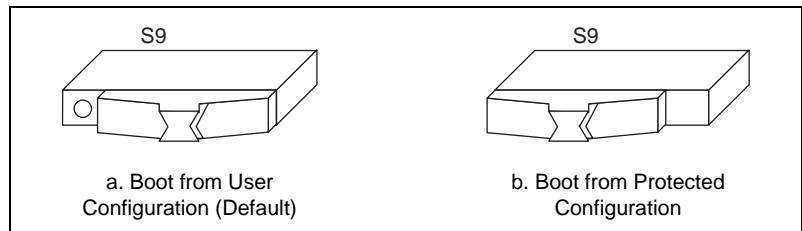

**Figure 3-8.** Power-On Self Configuration Status



The EEPROM is divided into two halves; one half is factory configured and one half is user configurable. Use switch S9 to control the operation of the EEPROM. The setting of this switch determines whether the VXIpc-800 boots off the factory-configured half or the user-modified settings. This is useful in the event that the user-configured half of the EEPROM becomes corrupted in such a way that the VXIpc-800 boots to an unusable state. In its default setting, the VXIpc-800 boots off the user-configurable half.

Figure 3-9 shows the configuration settings for EEPROM operation.



**Figure 3-9.** EEPROM Configuration

## How to Fix an Invalid EEPROM Configuration

The NI-VXI software includes a configuration utility you can use to edit the configuration of the VXIpc-800. Use T&M Explorer under Windows 95/NT, or VXIedit for all other platforms. Some of these settings are stored in files that are read by the NI-VXI software, while other settings are stored directly in the VXIpc-800 EEPROM. Certain EEPROM configurations can lock up your PCI computer while it is booting up. Generally, only the size and location of the memory windows can cause your VXIpc-800 to lock up your system. For example, many PCI-based computers will not boot if a board in its system requests more memory space than the computer can allocate. If you encounter this situation you should reduce the size of the VXIpc-800 user window.

If this situation occurs after you change the configuration, perform the following steps to reconfigure the VXIpc-800.

1. Turn your computer off.



**Warning:** *To protect both yourself and the mainframe from electrical hazards, the mainframe should remain off until you are finished changing the settings on the VXIpc-800 module.*

2. Change switch S9 to the OFF position as shown in Figure 3-9b to restore the factory configuration.
3. Turn on the computer. The computer should boot this time because the factory-default configuration is being used to initialize the VXIpc-800 module.
4. Run your software configuration utility to re-adjust the VXIpc-800 configuration.
5. After saving the configuration, exit Windows and turn off the computer.
6. Change switch S9 to the ON position, as shown in Figure 3-9a.
7. Turn on the computer. If the computer does not boot with this configuration, you will have to repeat these steps, modifying your configuration until a final configuration is reached.

## Installed System RAM

The 16 MB of installed RAM is factory configured per customer order. You can change the amount of installed RAM on the VXIpc 800 Series by installing DRAM SIMMs. Refer to Appendix A, *Specifications*, for more information on SIMMs.

## Configuring the PC

---

This section describes how to configure the following options on the PC:

- SCSI termination
- GPIB interrupt level
- System CMOS
- Parallel port DMA level
- Ethernet power-on defaults

## SCSI Termination

The VXIpc-800 uses active termination on the SCSI-2 bus. Because the VXIpc-800 is always an end device, you should not need to disable the termination; however, for informational purposes Figure 3-10 shows the jumper settings for both enabled and disabled termination.

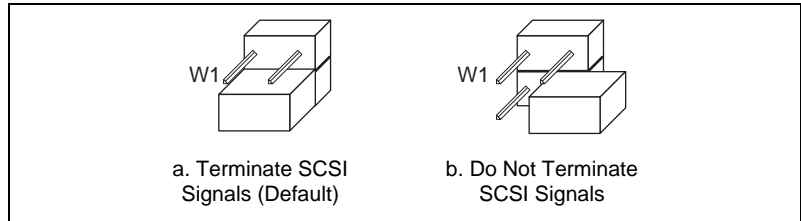

**Figure 3-10.** SCSI Termination

## GPIO Interrupt Level

You can program the GPIB interface on the VXIpc-800 to use one of two ISA interrupts—5 or 11. Switch S8 controls which interrupt line the GPIB interface uses. Figure 3-11 shows these settings.

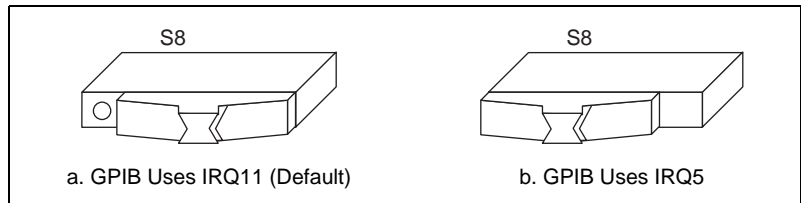

**Figure 3-11.** GPIB Interrupt Level

## System CMOS

The VXIpc-800 contains a backed-up memory used to store BIOS defaults and configuration information.

To clear the CMOS contents, simply short the pins of W2 as shown in Figure 3-12b.



**Caution:** *You should not keep these two pins shorted because the CMOS memory cannot be sustained when the power is turned off if these two pins are shorted.*

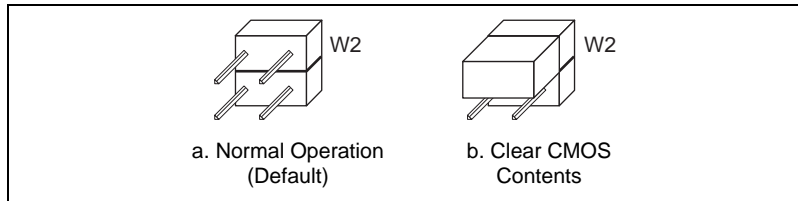

**Figure 3-12.** System CMOS

## Parallel Port DMA Level

You can use jumper W4 to configure the parallel port for either DMA level 1 or DMA level 3. Refer to Figure 3-13 for the jumper settings.

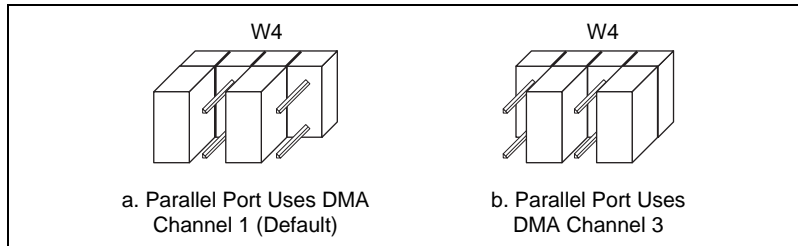

**Figure 3-13.** Parallel Port DMA Channel

## Ethernet Power-On Defaults

The VXIpc-800 Ethernet circuitry loads its power-on settings from an EEPROM. You should not change switch S1 from its default setting; however, the switch setting required to do so is included in Figure 3-14 for informational purposes.

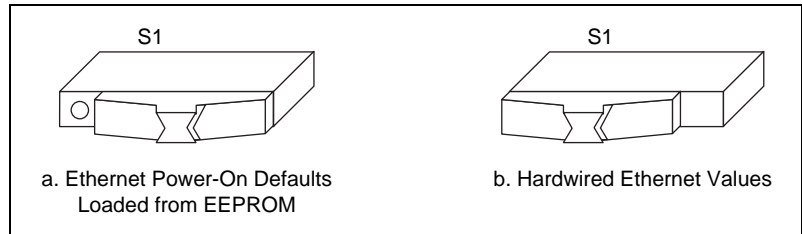

Figure 3-14. Ethernet Power-On Defaults

## Installing the VXIpc 800 Series

This section contains general installation instructions for the VXIpc-800. Consult your VXIbus mainframe user manual or technical reference manual for specific instructions and warnings.

1. Plug in your mainframe before installing the VXIpc-800. The power cord grounds the mainframe and protects it from electrical damage while you are installing the module.



**Warning:** *To protect both yourself and the mainframe from electrical hazards, the mainframe should remain off until you are finished installing the VXIpc-800 module.*

2. Remove or open any doors or covers blocking access to the mainframe slots.
3. If you are installing the VXIpc-800 into a D-size mainframe, install a support designed for installing C-size boards in D-size mainframes. The VXIpc-800 has no P3 connector and cannot provide P3 Slot 0 control to VXI devices requiring this capability.



**Caution:** *If the VXIpc-800 is not configured for automatic Slot 0 detection, be certain that the slot you select in your VXIbus mainframe matches the VXIpc-800 configuration as either a Slot 0 device or a Non-Slot 0 device. If you install your VXIpc-800 into a slot that does not correspond with the jumper setting, you risk damage to the VXIpc-800, the VXIbus backplane, or both.*

4. Insert the VXIpc-800 in the slot you have selected by aligning the top and bottom of the module with the card-edge guides inside the mainframe. Slowly push the VXIpc-800 straight into the slot until its plug connectors are resting on the backplane receptacle connectors. Using slow, evenly distributed pressure, press the module straight in until it seats in the expansion slot. The front panel of the VXIpc-800 should be even with the front panel of the mainframe.
5. Tighten the retaining screws on the top and bottom edges of the front panel.
6. Check the installation.
7. Connect the keyboard and mouse to the appropriate connectors. Use the keyboard adapter cable that you received with your kit to adapt AT-style keyboards to the VXIpc-800 mini-DIN connector.
8. Connect the VGA monitor video cable to the VGA connector.
9. Connect devices to ports as required by your system configuration. Some ports, such as the COM ports, have adapter cables that you can order from National Instruments.
10. Replace or close any doors or covers to the mainframe.

# BIOS

---

*Chapter*

**4**

This chapter contains information on BIOS, the low-level interface between the hardware and PC software that configures and tests your hardware at boot up. This BIOS (Basic Input Output System) provides an easy-to-use graphical user interface to allow you to configure system aspects according to your needs.

## Entering BIOS Setup

---

To enter the BIOS setup program, perform the following steps.

1. Turn on or reboot the system. A screen appears with a series of diagnostic checks.
2. When **Hit <DEL> if you want to run SETUP** appears, press the <DEL> key to enter the BIOS setup program.
3. Choose options with the keyboard. Modify the settings to reflect system options.

# Specifications

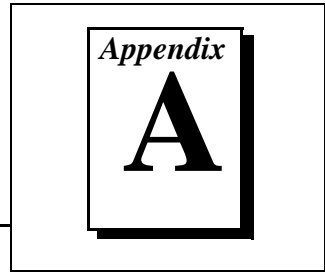

This appendix describes the environmental, electrical, and mechanical specifications of the VXIpc 800 Series embedded computer. Unless otherwise specified, these specifications apply to all models in the VXIpc 800 Series.

## Requirements

Characteristic	Specification
VXIbus Configuration Space	64 B
A24 or A32 Space	16 KB Minimum (Programmable)

## Electrical

VXIpc-850		
Voltage (V)	Current (A)	
	Typical	Maximum (Fused)
+5	5.82 A	12 A
-5.2	224.5 mA	2 A
-2	67.2 mA	2 A
+12	2.26 mA	2 A
-12	2.43 mA	2 A



<b>VXIpc-860</b>		
<b>Voltage (V)</b>	<b>Current (A)</b>	
	<b>Typical</b>	<b>Maximum (Fused)</b>
+5	8.52 A	12 A
-5.2	224.5 mA	2 A
-2	67.2 mA	2 A
+12	2.60 mA	2 A
-12	2.43 mA	2 A

## Physical

---

<b>Characteristic</b>	<b>Specification</b>
Size	Two-slot VXIbus C-Size Module (233.35 by 340 by 60.96 mm)
Board Dimensions	Fully Enclosed, Shielded VXI C-Size Board 233.35 by 340 mm (9.187 by 13.386 in.)
Slot Requirements	Two VXI C-Size Slots
Compatibility	Fully Compatible with VXI Specification
VXI Keying Class	Class 1 TTL
MTBF	VXIpc-850 22,094 hours VXIpc-860 25,001 hours
Weight	2.5 Kg (5.5 lb) Typical (16 MB DRAM Installed)

## Environmental

Characteristic	Specification
Temperature	0° to 55° C Operating; -20° to 70° C Storage
Relative Humidity	0% to 95% Noncondensing, Operating; 0% to 95% Noncondensing, Storage
EMI	FCC Class A Verified, EC Verified
Vibration	Operational: 5 to 500 Hz, 0.31 g, 3 axes Non-operational: 5 to 500 Hz, 2.5 g, 3 axes
Functional Shock	MIL-T-28800E Class 3 (per Section 4.5.5.4.1) Half-Sine Shock Pulse (11 ms duration, 30 g peak, 3 shocks per face)



**Note:** *Random vibration profiles were developed in accordance with MIL-T-28800E and MIL-STD-810E Method 514. Test levels exceed those recommended in MIL-STD-810E for Category 1 (Basic Transportation, Figures 514.4-1 through 514.4-3). Test report available upon request.*

## VMEbus Capability Codes

Capability Code	Description
A32, A24, A16 (master)	VMEbus master A32, A24, and A16 addressing
A32, A24, A16 (slave)	VMEbus slave A32, A24, and A16 addressing
D64, D32, D16, D08(E0) (master)	VMEbus master D64, D32, D16, and D08 data sizes
D64, D32, D16, D08(E0) (slave)	VMEbus slave D64, D32, D16, and D08 data sizes

<b>Capability Code</b>	<b>Description</b>
BLT, MBLT (master)	VMEbus master block and D64 transfers
BLT, MBLT (slave)	VMEbus slave block and D64 transfers
RMW (master)	VMEbus master read/modify/write transfers
RMW (slave)	VMEbus slave read/modify/write transfers
RETRY (master)	VMEbus master retry support
RETRY (slave)	VMEbus slave retry support
FSD	First slot detector
SCON	VMEbus System Controller (Automatic Detection)
PRI, RRS	Prioritized or Round Robin Select arbiter
ROR, FAIR	Release on Request and FAIR bus requester
IH(7-1)	Interrupt handler for levels 7-1
I(7-1)	Interrupt requester for levels 7-1
D32, D16, D08(O) (Interrupt Handler)	VMEbus D32, D16, D08(O) interrupt handler
D32, D16, D08(O) (Interrupter)	VMEbus D32, D16, D08(O) interrupter
ROAK, RORA	Release on Acknowledge or Register Access interrupter
BTO(x)	VMEbus bus timer (programmable limit)
LOCK	Can lock the VMEbus for indivisible transfers

## Adding RAM

---

To add RAM to the VXIpc 800, remove the top cover and add SIMM modules to the empty SIMM sockets.

National Instruments recommends the following types of SIMMs for use with the VXIpc-850 Series controller (Fast Page Mode):

8 MB: 2 MB x 36 SIMMs — 70 ns

16 MB: 4 MB x 36 SIMMs — 70 ns

32 MB: 8 MB x 36 SIMMs — 70 ns

The VXIpc-860 can use Fast Page Mode (FPM), Extended Data Out (EDO), or Bursts Extended Data Out (BEDO). National Instruments recommends the following types of SIMMs for use with the VXIpc-860:

8 MB: 2 MB x 32/36 SIMMs — 60 or 70 ns

16 MB: 4 MB x 32/36 SIMMs — 60 or 70 ns

32 MB: 8 MB x 32/36 SIMMs — 60 or 70 ns

64 MB: 16 MB x 32/36 SIMMs — 60 or 70 ns

The height of SIMMs used with VXIpc 800 Series controllers should be 0.85 in. or less. Contact National Instruments for recommendations on specific manufacturers.



**Note:** *The VXIpc-800 must be populated with pairs of SIMMs because the DRAM interface is 64 bits wide.*

# VXIpc 800 Series System Resources

---

## Appendix B

This appendix describes what system resources are available on the VXIpc 800 Series and where they are allocated. Because PCI is a relatively new addition to PCs, this appendix describes how PCI interrupts fit into a PC architecture before listing the devices that use them.

## PCI Interrupts

---

PCI interrupts can be shared by multiple devices and are therefore more flexible than ISA interrupts. They do not actually connect to the processor directly; they are instead mapped through ISA interrupts in the system I/O module. The interrupt handler for a particular ISA interrupt must know if it will be acknowledging a PCI device.

## Resource Tables

---

This section provides tables describing where system resources are assigned. Table B-1 lists how the ISA interrupts are allocated on the VXIpc 800 Series and whether they are driven by a PCI interrupt. Table B-2 lists DMA channel allocation, and Table B-3 gives the I/O address map.

**Table B-1.** VXIpc 800 Series ISA Interrupt Resource Allocations

ISA Interrupt	PCI Interrupt	Device
NMI	None	Parity
0	None	Timer
1	None	Keyboard
2	None	IRQ Expansion (8-15)
3	None	COM2
4	None	COM1

**Table B-1.** VXIpc 800 Series ISA Interrupt Resource Allocations (Continued)

ISA Interrupt	PCI Interrupt	Device
5	INTC, INTB	GPIB/PCMCIA Slot/Expansion
6	None	Floppy Drive
7	None	LPT1
8	None	RTC
9	None	Ethernet
10	INTA	VXI, SCSI, PCMCIA
11	None	GPIB/PCMCIA Slot/Expansion
12	None	Mouse
13	None	FPERR
14	INTD	IDE
15	None	PCMCIA Slot/Expansion

**Table B-2.** VXIpc 800 Series DMA Channel Resource Allocations

DMA Channel	Device
0	Free
1	Free
2	Floppy Drive
3	Free
4	Free
5	GPIB
6	Free
7	Free

**Table B-3.** VXIpc 800 Series I/O Address Map

<b>I/O Address</b>	<b>Device</b>
000-00F	8237 DMA #1
020-021	8259 PIC #1
040-043	8253 Timer
060-066	8742 Controller
070-077	CMOS RAM & NMI Mask Reg
078-07B	BIOS Timer
080-090	DMA Page Registers
092	Reserved
094-09F	DMA Page Registers
0A0-0A1	8259 PIC #2
0B2-0B3	Advanced Power Management
0C0-0DF	8237 DMA #2 (word mapped)
0F0-0FF	Numeric Processor Error Reg
170-177	Reserved
1F0-1F7	IDE
200-270	Free
278-27F	LPT*
280-2DF	Free
2C0-2DF	GPIB
2E8-2EF	COM*
2F8-2FF	COM*
300-30F	Ethernet
310-36F	Free
370-377	Reserved
378-37F	LPT*
380-3B0	Free
3BC-3BF	LPT*

# LED Indicators

---

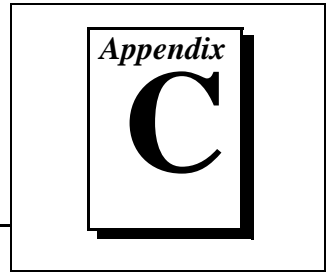

This appendix describes how to read the LEDs on the front panel to interpret the status of the VXIpc 800 Series.

## VXIbus Interface Status LEDs

---

The VXIbus interface status LEDs are located at the top of the module and include four LEDs: **FAILED**, **SYSFAIL**, **ONLINE**, and **TEST**. They indicate the various stages of initialization that occur as the VXIpc 800 boots. The following paragraphs describe each LED.

### SYSFAIL LED

The **SYSFAIL** LED is lit when the VMEbus SYSFAIL signal is asserted. It does not necessarily indicate that the VXIpc 800 is asserting SYSFAIL, only that there is a device in the system asserting SYSFAIL.

### FAILED LED

The **FAILED** LED is lit when the VXIpc 800 is driving the SYSFAIL signal. The VXIpc 800 asserts SYSFAIL when the PASSED bit in its VXIbus status register is clear. The PASSED bit is set by the power-on self configuration circuitry (POSC) when it has completed initializing the VXIbus interface.

### ONLINE LED

The **ONLINE** LED is lit when the Resource Manager has successfully completed and the VXIbus interface is ready for application programs.

### TEST LED

The **TEST** LED is lit when the power-on self configuration circuitry is configuring the VXIbus interface.



## LEDs and System Startup Cycle

Table C-1 shows a system startup cycle and possible points of failure, up to and including the state in which the `VXIinit` initialization program asserts the **ONLINE** LED.

**Table C-1.** LEDs and System Startup Status

Step	LEDs Lit	Status	Possible Problem if VXIpc 800 Fails
1	None	Machine just turned on.	The VXIpc 800 is not receiving power.
2	<b>FAILED, SYSFAIL</b>	Now asserting SYSFAIL because VXIbus interface has not been initialized yet.	Power-on self configuration (POSC) cannot execute because of problems with system reset or because the POSCEN switch is incorrectly configured.
3	<b>FAILED, TEST</b>	VXI interface is being initialized by MITE power-on self configuration (POSC) circuitry.	POSC has stalled.
4	<b>TEST</b>	POSC circuitry has initialized VXI interface, setting PASSED and DONE bits.	POSC stalled before clearing the <b>TEST</b> LED.
5	None	POSC cycles are complete. VXI port is ready to respond to Resource Manager inquiries.	POSC completed successfully; however, the Resource Manager either hung or was not executed.
6	<b>ONLINE</b>	Resource Manager has been executed, indicating that the VXI software can now communicate with the VXI circuitry.	Resource Manager interface initialized successfully.

If either the **SYSFAIL** or **FAILED** LED remains lit, perform the following steps.

1. Power off the mainframe.
2. Remove all other modules from the mainframe.
3. Make sure that the VXIpc 800 jumper settings are correct.
4. Make sure that the VXIpc 800 is seated properly in the mainframe.
5. Power on the mainframe and observe whether the **SYSFAIL** and **FAILED** LEDs become unlit some time before the operating system boots.

## Board Access LEDs

---

The board access LEDs—**ACCESS** and **DRIVE**—indicate when board resources have been accessed. The following paragraphs describe these LEDs.

### ACCESS LED

When lit, the **ACCESS** LED indicates that the VXIpc 800 MODID line is asserted or that another VXIbus master is accessing VXIbus shared registers or shared memory.

### DRIVE LED

The **DRIVE** LED light indicates that an access to the internal hard disk drive is occurring.

## Ethernet LEDs

---

The Ethernet LEDs (**RX**, **TX**, **LINK**, and **DSEL**) indicate the status of the Ethernet interface on the VXIpc 800 Series.

### RX LED

The **RX** LED lights when the Ethernet interface is receiving a packet.

### TX LED

The **TX** LED lights when the Ethernet interface is transmitting a packet.

## LINK LED

The **LINK** LED indicates LINK status and can generally be used to check if Ethernet activity is occurring.

## DSEL LED

The **DSEL** (Device Select) LED lights when Ethernet registers are being accessed.

# Front Panel and Connectors

---

Appendix

D

This appendix describes the front panel and connectors on the VXIpc 800 Series. This material contains the information relevant to VXIplug&play Specification VPP-8, *VXI Module/Mainframe to Receiver Interconnection*.



**Note:** *The illustrations in this appendix show the mating face of the connectors. An asterisk suffix (\*) on a signal name indicates that the signal is active low.*

The VXIpc 800 Series has the following front panel connectors:

- Two RS-232 Serial
- Extended Capabilities Parallel (ECP)
- VGA Controller
- IEEE 488.2
- 10BaseT Ethernet
- SCSI-2
- External Clock
- Trigger Output
- Trigger Input
- Audio Output
- PS/2-Style Keyboard
- PS/2-Style Mouse

# Front Panel

Figure D-1 shows the front panel layout of the VXIpc-800. The drawing shows dimensions relevant to key elements on the front panel. Dimensions are shown in inches and millimeters, with millimeter dimensions in square brackets. The front panel thickness for all models in the VXIpc 800 Series is 2.49 mm (0.098 in.).

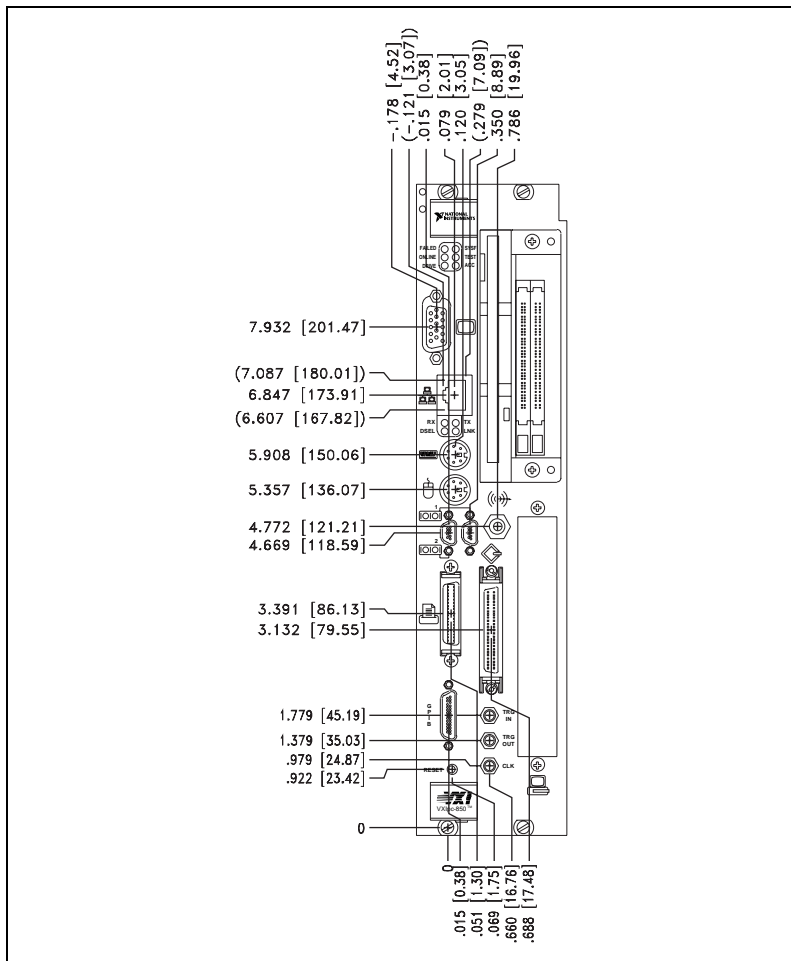
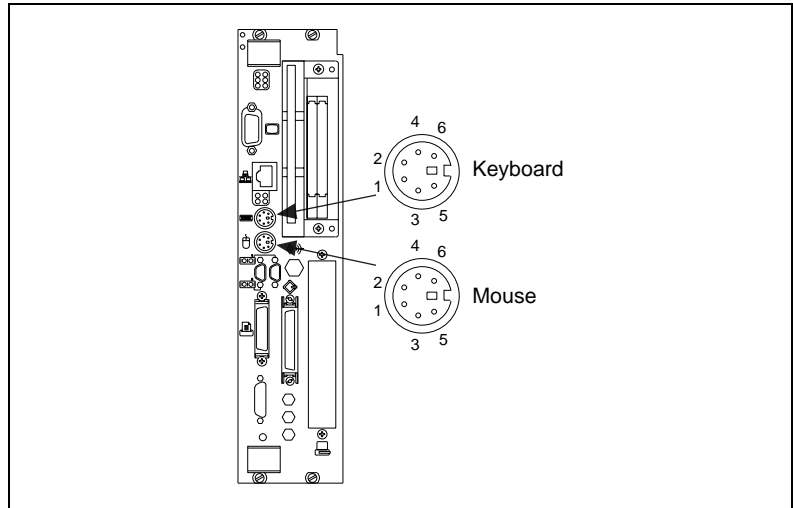

**Figure D-1.** VXIpc-800 Front Panel Layout and Dimensions

# Keyboard and Mouse

Figure D-2 shows the location and pinouts for the keyboard and mouse connectors on the VXIpc 800 Series. Table D-1 gives the name and description for the keyboard and mouse connector signals.

Amp manufactures a mating connector with part numbers 212437-4 (housing), 212435-7 (ferrule), and 66735-4 (pin contact).



**Figure D-2.** Keyboard and Mouse Connectors Location and Pinout

**Table D-1.** Keyboard and Mouse Connector Signals

Pin	Signal Name	Signal Description
1	DATA	Data
2	NC	Not Connected
3	GND	Ground
4	+5V	+5 volts
5	CLK	Clock
6	NC	Not Connected

# VGA

Figure D-3 shows the location and pinouts for the VGA connector on the VXIpc 800 Series. Table D-2 gives the name and description for the VGA connector signals.

Amp manufactures a mating connector with part numbers 748364-1 (housing) and 748333-2 (pin contact).

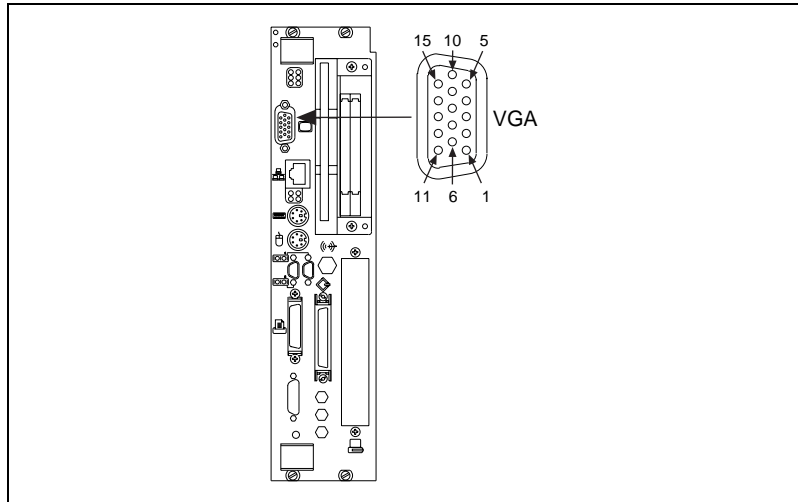

**Figure D-3.** VGA Connector Location and Pinout

**Table D-2.** VGA Connector Signals

Pin	Signal Name	Signal Description
1	R	Red
2	G	Green
3	B	Blue
4	NC	Not Connected
5	GND	Ground
6	GND	Ground
7	GND	Ground
8	GND	Ground

**Table D-2.** VGA Connector Signals (Continued)

Pin	Signal Name	Signal Description
9	+5 VDC	+5 VDC
10	GND	Ground
11	NC	Not Connected
12	SD	Serial Data
13	HSync	Horizontal Sync
14	VSync	Vertical Sync
15	SC	Serial Clock

## Ethernet

Figure D-4 shows the location and pinouts for the Ethernet connector on the VXIpc-800. Table D-3 gives the name and description for the Ethernet connector signals.

Amp manufactures a mating connector, part number 554739-1.

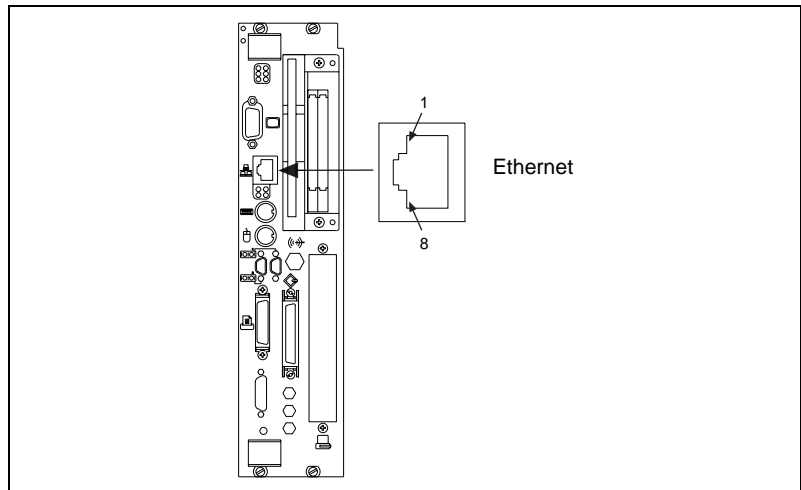
**Figure D-4.** Ethernet Connector Location and Pinout



**Table D-3.** Ethernet Connector Signals

<b>Pin</b>	<b>Signal Description</b>
1	Differential Transmit
2	Differential Transmit
3	Differential Receive
4	NC
5	NC
6	Differential Receive
7	NC
8	NC

## COM1 and COM2

---

Figure D-5 shows the location and pinouts for the COM1 and COM2 connectors on the VXIpc 800. Table D-4 gives the name and description for the COM1 and COM2 connector signals.

ITT Cannon manufactures a serial port mating connector, part number MDSM-9SC-Z11, for the COM1 and COM2 connectors on the VXIpc-800.

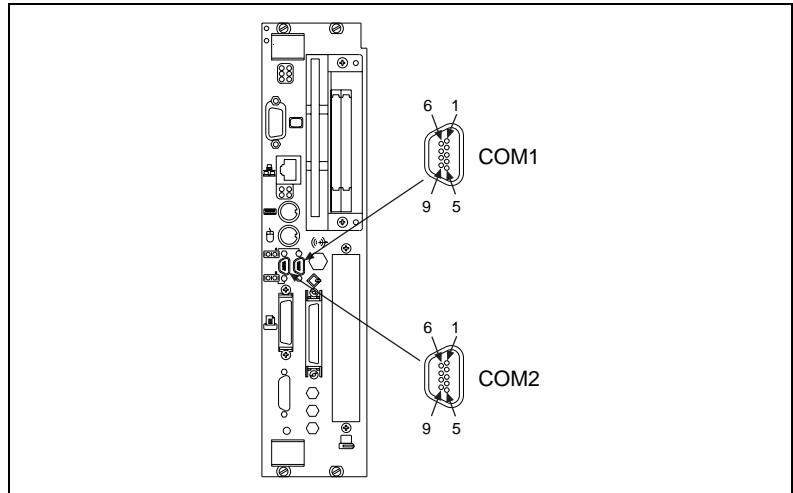

**Figure D-5.** COM1 and COM2 Connectors Location and Pinout

**Table D-4.** COM1 and COM2 Connector Signals

Pin	Signal Name	Signal Description
1	DCD*	Data Carrier Detect
2	RXD*	Receive Data
3	TXD*	Transmit Data
4	DTR*	Data Terminal Ready
5	GND	Ground
6	DSR*	Data Set Ready
7	RTS*	Ready to Send
8	CTS*	Clear to Send
9	RI*	Ring Indicator

# Parallel Port

Figure D-6 shows the location and pinouts for the IEEE-1284 connector on the VXIpc-800. Table D-5 gives the name and description for the IEEE-1284 connector signals.

Amp manufactures a parallel port compatible connector, part number 2-175677-5.

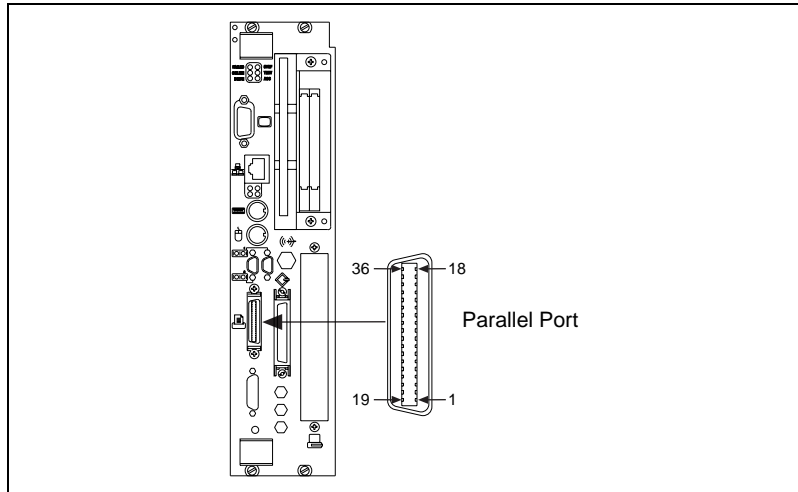

**Figure D-6.** Parallel Port Connector Location and Pinout

**Table D-5.** Parallel Port Connector Signals

<b>Pin</b>	<b>Signal Name</b>	<b>Signal Description</b>
1	BUSY*	Device Busy
2	SLCTIN*	Select Input
3	ACK*	Acknowledge
4	FAULT*	Fault
5	ERROR	Error
6	PD0	Data Bit 0
7	PD1	Data Bit 1
8	PD 2	Data Bit 2
9	PD3	Data Bit 3
10	PD4	Data Bit 4
11	PD5	Data Bit 5
12	PD6	Data Bit 6
13	PD7	Data Bit 7
14	INIT*	Initialize Printer
15	STROBE*	Strobe
16	SLCT	Select
17	AUTOFD	Auto Line Feed
18	+5V	+5 Volts
19-35	GND	Ground
36	NC	Not Connected

# SCSI

Figure D-7 shows the location and pinouts for the SCSI connector on the VXIpc-800. Table D-6 gives the name and description for the SCSI connector signals.

Amp manufactures a SCSI compatible connector, part number 749111-4.

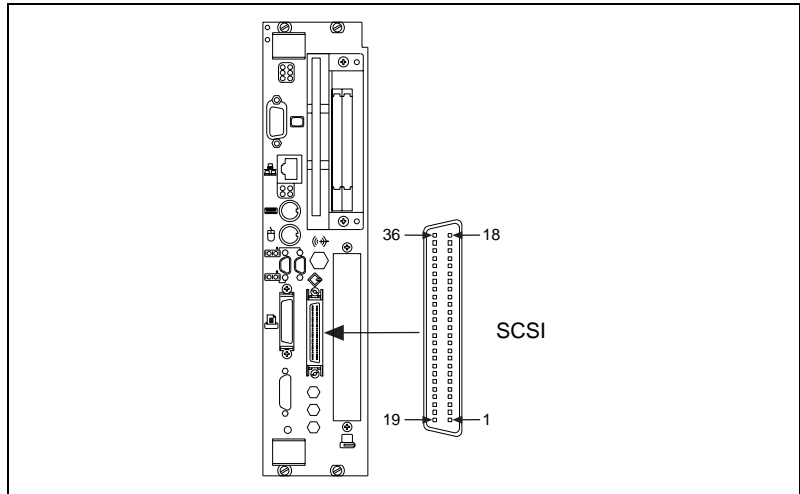

**Figure D-7.** SCSI Connector Location and Pinout (SCSI II)

**Table D-6.** SCSI Connector Signals

<b>Pin</b>	<b>Signal Name</b>	<b>Signal Description</b>
1–11, 15–25, 35–36, 40, 42	GND	Ground
12–14, 37–39	NC	Not Connected
26	D0	Data 0
27	D1	Data 1
28	D2	Data 2
29	D3	Data 3
30	D4	Data 4
31	D5	Data 5
32	D6	Data 6
33	D7	Data 7
34	DP	Parity
38	TERMPWR	Termination Power
41	ATN*	Attention
43	BUSY*	Busy
44	ACK*	Acknowledge
45	RESET*	Reset
46	MSG*	Message
47	SEL*	Select
48	CMD_DATA	Command/Data
49	REQ*	Request
50	IN_OUT	In/Out

## GPIB (IEEE-488.2)

Figure D-8 shows the location and pinouts for the GPIB connector on the VXIpc-800. Table D-7 gives the name and description for the GPIB connector signals.

ITT Cannon manufactures a GPIB mating connector, part number MDSM-255C-Z11.

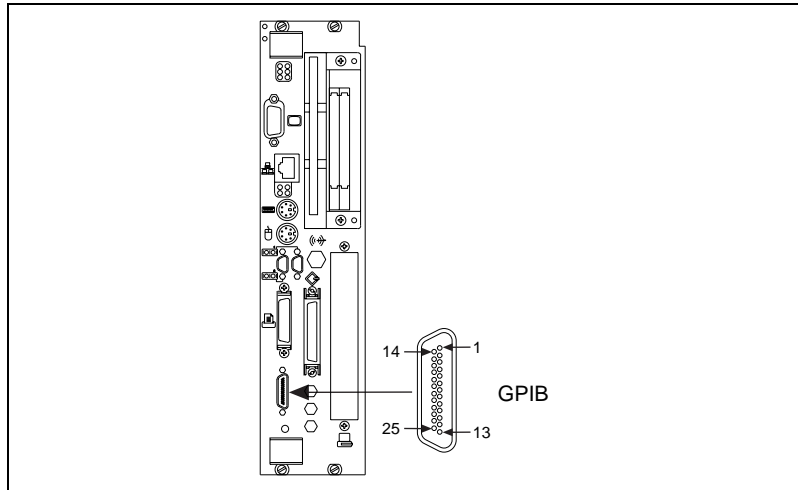

**Figure D-8.** GPIB Connector Location and Pinout

**Table D-7.** GPIB Connector Signals

<b>Pin</b>	<b>Signal Name</b>	<b>Signal Description</b>
1	DIO1*	Data Bit 1
2	DIO2*	Data Bit 2
3	DIO3*	Data Bit 3
4	DIO4*	Data Bit 4
5	EOI*	End or Identify
6	DAV*	Data Valid
7	NRFD*	Not Ready for Data
8	NDAC*	Not Data Accepted
9	IFC*	Interface Clear
10	SRQ*	Service Request
11	ATN*	Attention
12	SHIELD	Chassis ground
13	DIO5*	Data Bit 5
14	DIO6*	Data Bit 6
15	DIO7*	Data Bit 7
16	DIO8*	Data Bit 8
17	REN*	Remote Enable
18-25	GND	Logic Ground



## External SMBs

Figure D-9 shows the location and pinouts for the SMB connectors on the VXIpc 800. The SMB connectors are used for an external clock signal and TTL trigger input and output. Table D-8 gives the name and description for the SMB connector signals. Also see Table D-9 for a description of the signal characteristics for the SMB connections.

Amp manufactures an SMB mating connector, part number 1-413985-0.

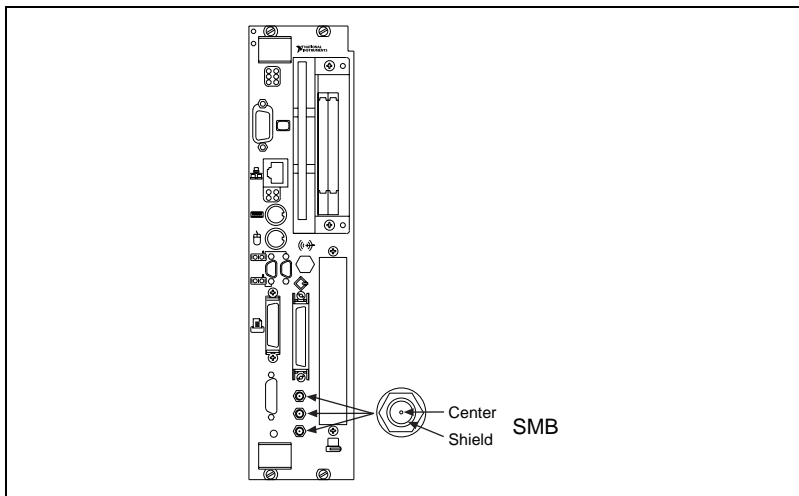

**Figure D-9.** SMB Connectors Location and Pinout

**Table D-8.** SMB Connector Signals

Pin	Signal Description
Center	TTL Trigger or Clock Signal
Shield	Ground

# Speaker

Figure D-10 shows the location of the speaker connection on the VXIpc-800.

Switchcraft manufactures a mating speaker connector, part number 750.

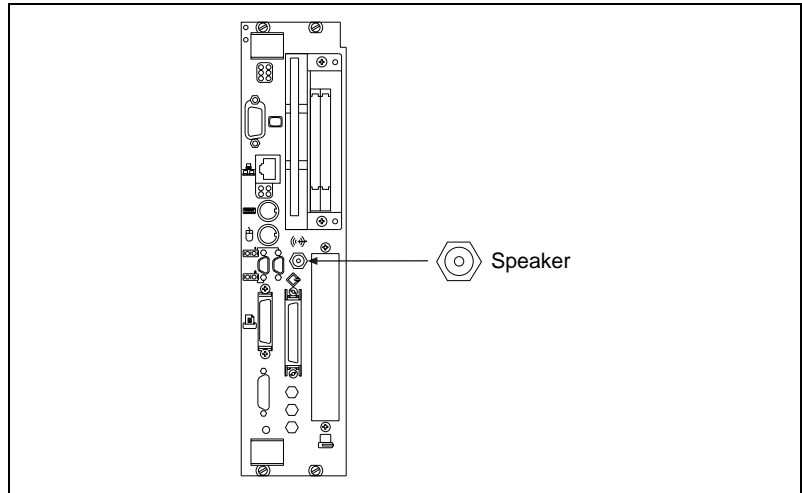

**Figure D-10.** Speaker Connection Location

## Signal Characteristics

---

Refer to the relevant standard for the signal characteristics for VGA, SCSI, Ethernet, keyboard, mouse, parallel, serial, and GPIB.

Table D-9 shows the signal characteristics for the SMB and speaker connections.

**Table D-9.** Signal Characteristics for SMB and Speaker Connections

Signal	Voltage Range	Maximum Current	Frequency Range
SMB (TRIG out, CLK out)	0 to 3.4 V	200 mA	DC-10 MHz
Speaker	0 to 4.3 V	75 mA	DC-20 kHz
SMB (TRIG in)	0 to 5 V	100 mA*	DC-10 MHz
* with 50 $\Omega$ termination			

## VXibus P1 and P2

Figure D-11 shows the location and pinouts for the VXibus connector on the VXIpc 800 Series. Table D-10 gives the name and description for the VXibus P2 connector signals. Table D-11 gives the name and description for the VXibus P1 connector signals.

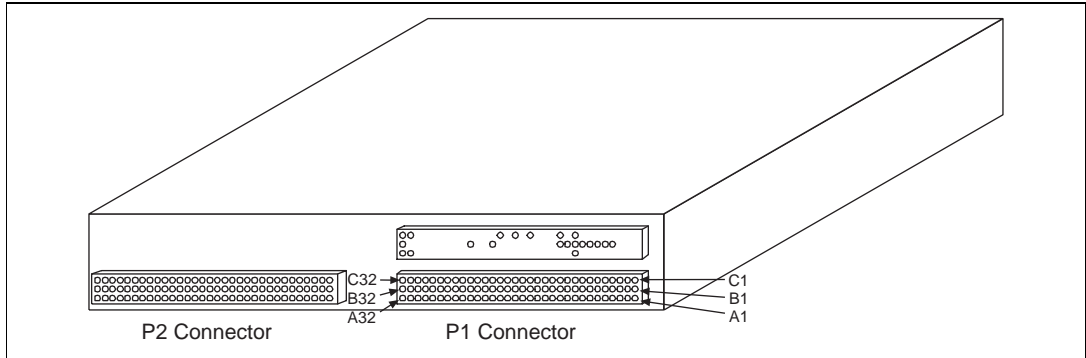

**Figure D-11.** VXibus Connectors Location and Pinout

**Table D-10.** VXibus P2 Connector Signals

Pin	Row C	Row B	Row A
1	CLK10+	+5 V	ECLTRG0
2	CLK10-	GND	-2 V
3	GND	Not Connected	ECLTRG1
4	-5.2 V	A24	GND
5	Not Connected	A25	MODID12
6	Not Connected	A26	MODID11
7	GND	A27	-5.2 V
8	Not Connected	A28	MODID10
9	Not Connected	A29	MODID09
10	GND	A30	GND
11	Not Connected	A31	MODID08
12	Not Connected	GND	MODID07

**Table D-10.** VXIbus P2 Connector Signals (Continued)

<b>Pin</b>	<b>Row C</b>	<b>Row B</b>	<b>Row A</b>
13	-2 V	+5 V	-5.2 V
14	Not Connected	D16	MODID06
15	Not Connected	D17	MODID05
16	GND	D18	GND
17	Not Connected	D19	MODID04
18	Not Connected	D20	MODID03
19	-5.2 V	D21	-5.2 V
20	Not Connected	D22	MODID02
21	Not Connected	D23	MODID01
22	GND	GND	GND
23	TTLTRG1*	D24	TTLTRG0*
24	TTLTRG3*	D25	TTLTRG2*
25	GND	D26	+5 V
26	TTLTRG5*	D27	TTLTRG4*
27	TTLTRG7*	D28	TTLTRG6*
28	GND	D29	GND
29	Not Connected	D30	Not Connected
30	GND	D31	MODID00
31	Not Connected	GND	GND
32	Not Connected	+5 V	Not Connected

**Table D-11.** VXIbus P1 Connector Signals

<b>Pin</b>	<b>Row C</b>	<b>Row B</b>	<b>Row A</b>
1	D08	BBSY*	D00
2	D09	BCLR*	D01
3	D10	ACFAIL*	D02
4	D11	BG0IN*	D03
5	D12	BG0OUT*	D04
6	D13	BG1IN*	D05
7	D14	BG1OUT*	D06
8	D15	BG2IN*	D07
9	GND	BG2OUT*	GND
10	SYSFAIL*	BG3IN*	SYSCLK
11	BERR*	BG3OUT*	GND
12	SYSRESET*	BR0*	DS1*
13	LWORD*	BR1*	DS0*
14	AM5	BR2*	WRITE*
15	A23	BR3*	GND
16	A22	AM0	DTACK*
17	A21	AM1	GND
18	A20	AM2	AS*
19	A19	AM3	GND
20	A18	GND	IACK*
21	A17	Not Connected	IACKIN*
22	A16	Not Connected	IACKOUT*
23	A15	GND	AM4
24	A14	IRQ7*	A07
25	A13	IRQ6*	A06
26	A12	IRQ5	A05
27	A11	IRQ4	A04

**Table D-11.** VXIbus P1 Connector Signals (Continued)

<b>Pin</b>	<b>Row C</b>	<b>Row B</b>	<b>Row A</b>
28	A10	IRQ3	A03
29	A09	IRQ2	A02
30	A08	IRQ1	A01
31	+12 V	Not Connected	-12 V
32	+5 V	+5 V	+5 V

# Modifying and Installing I/O Expansion Boards

## Appendix E

This appendix explains how to modify and install an I/O board in the VXIpc 800 Series. Notice that some material is different between the VXIpc-850 and the VXIpc-860.

## Height of VXIpc-850 Plug-In Boards

In general, the VXIpc-850 can accommodate any standard-size PCI card and any XT-height ISA card. The height of an I/O card is measured from the bottom of the bus connector to the top of the board, as shown in Figure E-1.

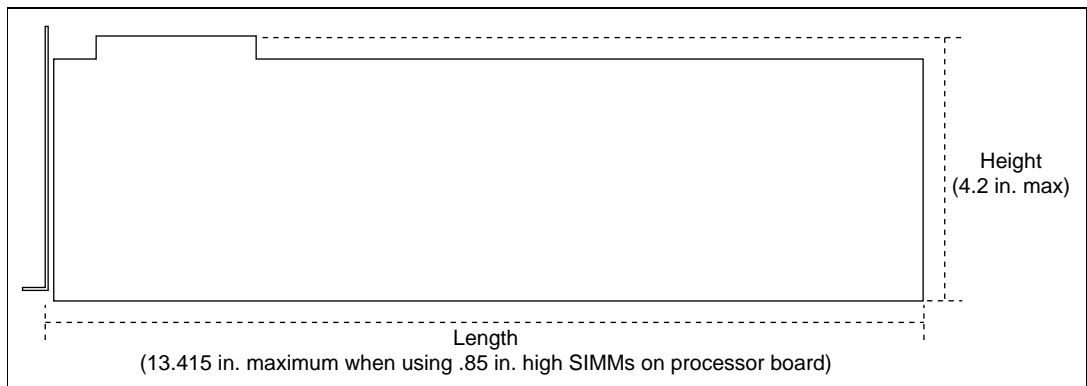

**Figure E-1.** I/O Board Dimensions for VXIpc-850 Expansion Slot

Both XT-height ISA cards and PCI cards are 4.2 in. high. The VXIpc-850 does not support AT-height ISA cards, which are 4.8 in. high.



## Length of VXIpc-850 Plug-In Boards

The VXIpc-850 will accommodate PCI or ISA I/O boards that are up to 4.2 in. high and up to 13.415 in. long when DRAM SIMMs 0.85 in. or shorter are used on the processor board (National Instruments provides 0.85 in. SIMMs). Due to slight variances in I/O board geometries, however, take care in every application to identify possible contact with the SIMMs. The maximum recommended board length is 7.72 in. if you are using SIMMs taller than 0.85 in. If you want to install a longer board with taller system DRAM SIMMs, you must consider the strong possibility of contact with the SIMMs.

Because DRAM SIMMs taller than 0.85 in. are more likely to interfere with ISA cards than PCI cards, the two are discussed separately in the following sections.

### Length of PCI Plug-In Boards

The VXIpc-850 accommodates any standard 32-bit, 5 V PCI I/O board. The maximum standard dimensions of a PCI I/O board are 12.283 in. by 4.2 in. PCI cards are installed in the VXIpc-850 such that the board components face the processor card, which contains the processor and system RAM. Exceptionally tall PCI components (higher than 0.52 in.) on a plug-in board may physically contact the DRAM SIMMs installed on the CPU card, as shown in Figure E-2.

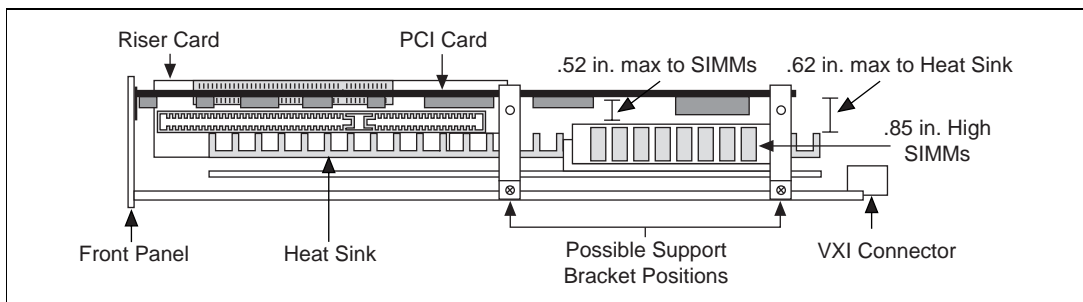

**Figure E-2.** Component Height Restrictions for PCI Plug-In Boards Used with the VXIpc-850

Because larger DRAM sizes may employ taller SIMMs, you must be careful that the component height of the PCI board does not interfere with the SIMMs in such a way that electrical shorts occur or that the PCI board is stressed enough to compromise its physical or electrical integrity.

## Length of ISA Plug-In Boards

Because ISA boards mount with the components facing away from the CPU card, which contains the processor and system RAM, tall DRAM SIMMs may interfere with the circuit card of the plug-in board. Most SIMM modules are at least 1 in. high and would extend into the ISA circuit card keepout area. Therefore, National Instruments provides SIMMs of 0.85 in. high, and does not recommend the use of cards that are longer than 7.72 in. if you choose to use taller SIMMs. They can be made to fit; however, take care to ensure the following conditions:

- Contact of the board with the SIMMs should not cause electrical shorts (because of through-hole component leads on the side of the plug in board that contacts the SIMMs).
- Contact of the board with the SIMMs does not cause physical stress to the plug-in board.
- Contact of the board with the SIMMs does not cause physical stress to the riser board into which the plug-in board is inserted.

Figure E-3 shows the length restrictions for ISA cards for the VXIpc-850 when tall SIMMs are used.

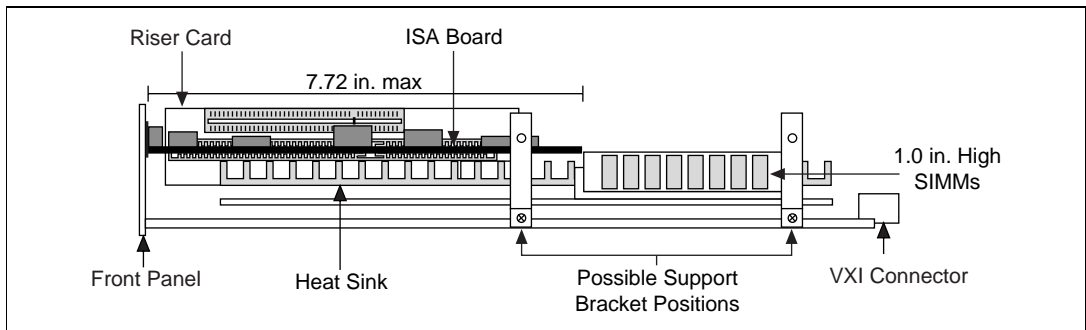

**Figure E-3.** Length Restrictions for ISA Plug-In Boards Used with the VXIpc-850 when SIMMs Taller than 0.85 in. are Used

## Height of VXIpc-860 Plug-In Boards

In general, the VXIpc-860 can accommodate any standard-size PCI card and any XT-height ISA card. The height of an I/O card is measured from the bottom of the bus connector to the top of the board, as shown in Figure E-4.

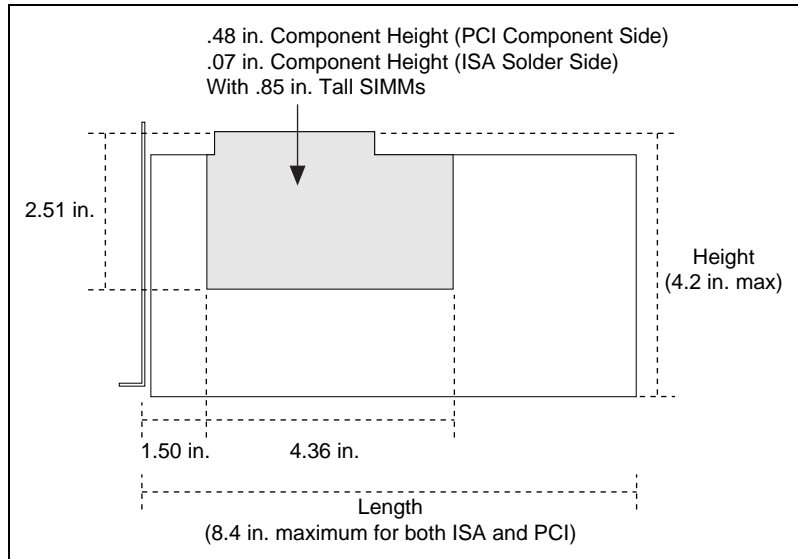

**Figure E-4.** I/O Board Dimensions for VXIpc-860 Expansion Slot

Both XT-height ISA cards and PCI cards are 4.2 in. high. The VXIpc-860 does not support AT-height ISA cards, which are 4.8 in. high.

## Length of VXIpc-860 Plug-In Boards

The VXIpc-860 can accommodate PCI or ISA I/O boards that are up to 4.2 in. high and up to 8.4 in. long. When DRAM SIMMs 0.85 in. are used on the processor board, the component-side component height on a PCI I/O board shall be 0.48 in. tall in the area shown in Figure E-4. For the same height DRAM SIMMs, the ISA I/O board solder-side component height shall be 0.07 in. tall in the area shown in Figure E-4. Be sure to allow for clearance if you want to use taller DRAM SIMMs.

Because DRAM SIMMs taller than 0.85 in. are more likely to interfere with ISA cards than PCI cards, the two are discussed separately in the following sections.

### Length of PCI Plug-In Boards

The VXIpc-860 accommodates any 32-bit, 5 V PCI I/O boards that are a maximum of 8.4 in. long with the standard height of 4.2 in. (see Figure E-5). PCI cards are installed in the VXIpc-860 such that the board components face the processor board, which contains the processor and system RAM. PCI components (higher than 0.48 in. in the area shown in Figure E-4) on a plug-in board may physically contact the DRAM SIMMs installed on the CPU card, as shown in Figure E-5.

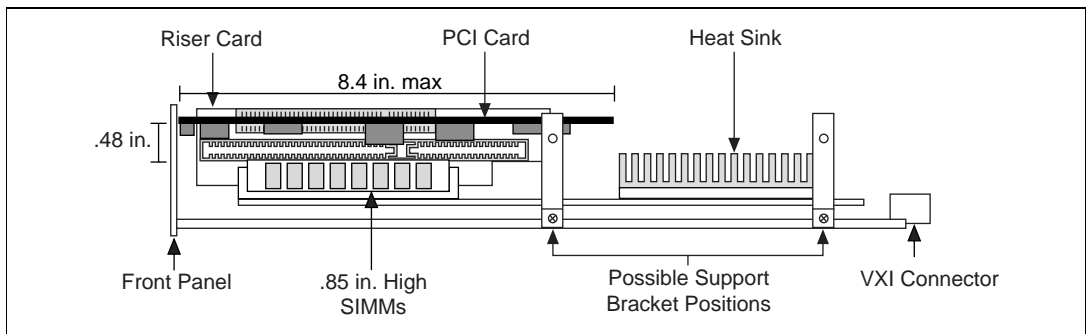

**Figure E-5.** Length Restrictions for PCI Plug-In Boards Used with the VXIpc-860

Because larger DRAM sizes may employ taller SIMMs, you must be careful that the component height of the PCI board does not interfere with the SIMMs in such a way that electrical shorts occur or that the PCI board is stressed enough to compromise its physical or electrical integrity.

## Length of ISA Plug-In Boards

Because ISA boards mount with the components facing away from the CPU card, which contains the processor and system RAM, tall DRAM SIMMs may interfere with the circuit card of the plug-in board. Most SIMM modules are at least 1 in. high and would extend into the ISA circuit card. Therefore, National Instruments provides SIMMs of 0.85 in. high to give a clearance of 0.07 in. to the ISA circuit card only in the area shown in Figure E-4. If you choose to use taller SIMMs (0.92 maximum height), take care to ensure the following conditions:

- Contact of the board with the SIMMs should not cause electrical shorts (because of through-hole component leads on the side of the plug in board that contacts the SIMMs).
- Contact of the board with the SIMMs does not cause physical stress to the plug-in board.
- Contact of the board with the SIMMs does not cause physical stress to the riser board into which the plug-in board is inserted.

Figure E-6 shows the length restrictions for ISA cards for the VXIpc-860 when tall SIMMs are used.

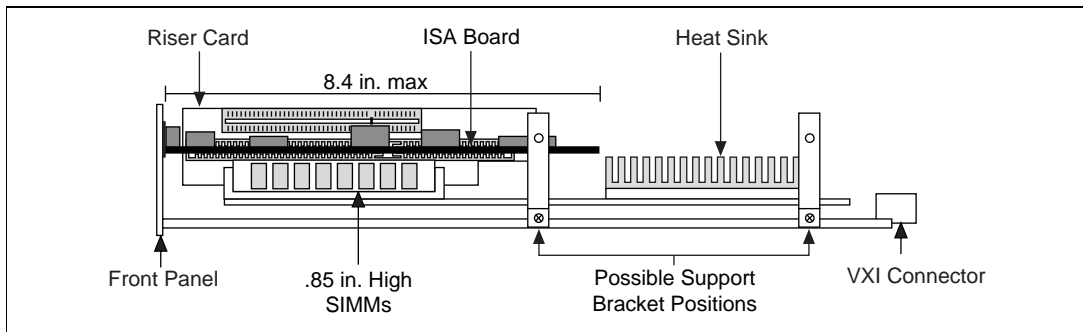

**Figure E-6.** Length Restrictions for ISA Plug-In Boards Used with the VXIpc-860 when SIMMs Taller than 0.85 in. are Used

# Installing an I/O Board

---

The following material applies equally to all models in the VXIpc 800 Series.

## Materials Needed

You need the following pieces to install an expansion board in the VXIpc-800:

- A user-defined panel is required on the expansion boards based on National Instruments blank PCI or ISA panels. The panel should be manufactured from 0.03 in. (0.76 mm) thick 1010 cold rolled steel. The finish should be 0.0003 in. (0.008 mm) nickel plate over 0.0001 in. (0.003 mm) copper flash. Contact National Instruments if you have any questions about specifications for user-defined panels.

As an alternative, you can modify the blank panels provided with the VXIpc-800. Custom panel design services are available from National Instruments for a nominal fee.

- PEM nut or a 4-40 nut with lock washer (hole diameter should be 0.125 in. [3.18 mm]).
- 4-40 x 1/4 in. stainless steel panhead screw.

## Installation Steps

Follow these steps to install the expansion board.

1. Notice that the VXIpc-800 includes one card guide that can be rotated to secure the top of either a PCI or an ISA plug-in board. You may use the card guide in either of two locations, depending on the length of your installed board. Notice the possible locations as shown previously (Figures E-2 and E-3 for the VXIpc-850, or Figures E-5 and E-6 for the VXIpc-860). Loosen the screw holding the guide and rotate the guide to the uppermost position for PCI boards or the lowermost position for ISA boards. See Figure E-7.
2. Replace the manufacturer-supplied panel bracket with the custom bracket. The two holes in the bracket align with existing holes in the VXIpc-800 front panel.
3. Seat the board firmly in one of the expansion bus connectors.
4. Attach the board to the front panel with the two screws. You can use a PEM nut on the back (far) side of the bracket, or a 4-40 nut

with a lock washer (hole diameter should be 0.125 in.). In either case, use a 4-40 x 1/4 in. stainless steel panhead screw to mount the board/bracket assembly to the front panel.

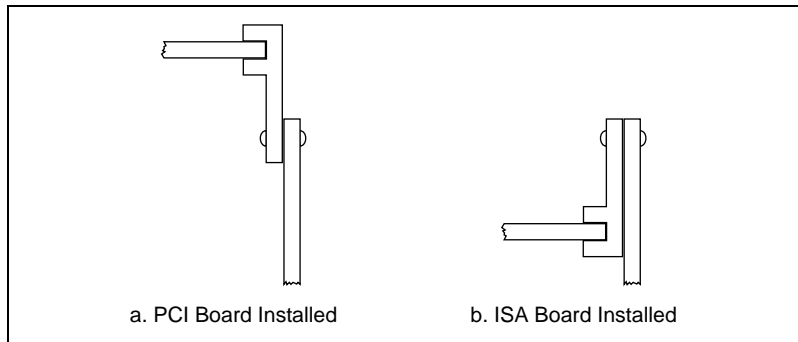
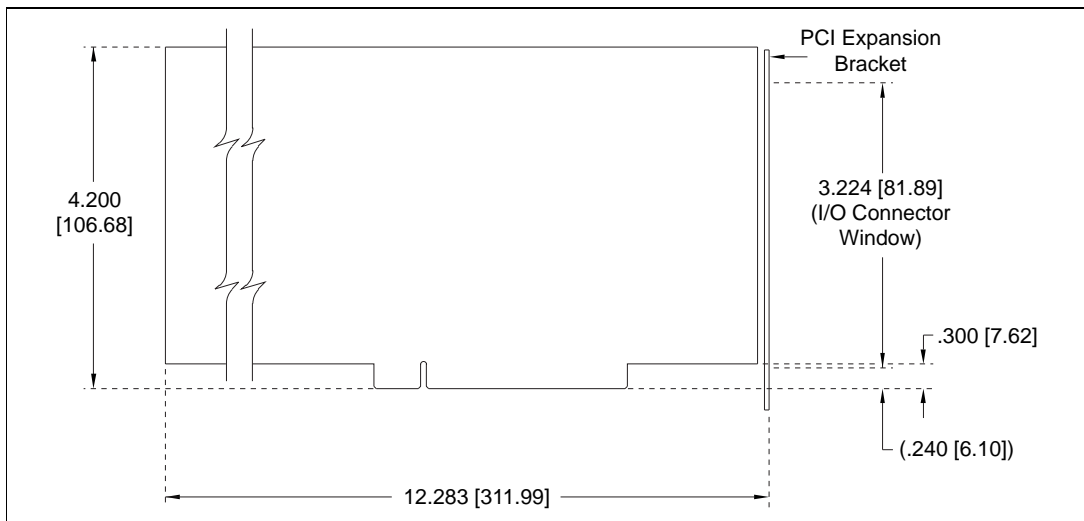

**Figure E-7.** PCI Board and ISA Board Installed in a VXIpc-800

Figures E-8 and E-9 give dimensions and instructions for creating a connector cutout and expansion bracket for a PCI board.



**Note:** *In the following drawings, dimensions are given in inches and millimeters, with the millimeter dimensions in square brackets.*



**Figure E-8.** Side View of PCI Board with Expansion Bracket

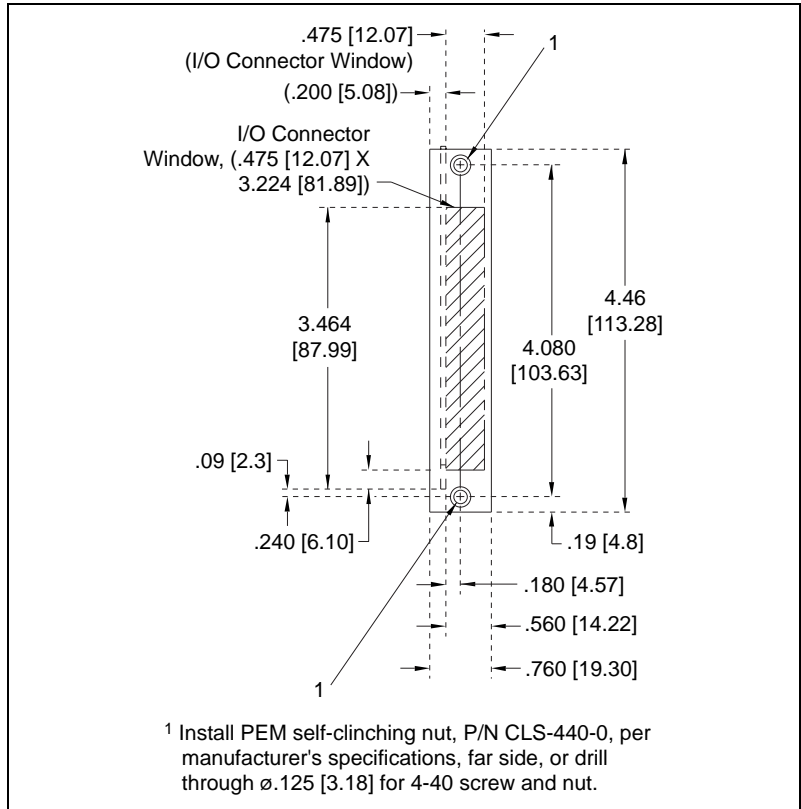

**Figure E-9.** Front View of PCI Board Expansion Bracket



Figures E-10 and E-11 give dimensions and instructions for creating a connector cutout and expansion bracket for an ISA board.

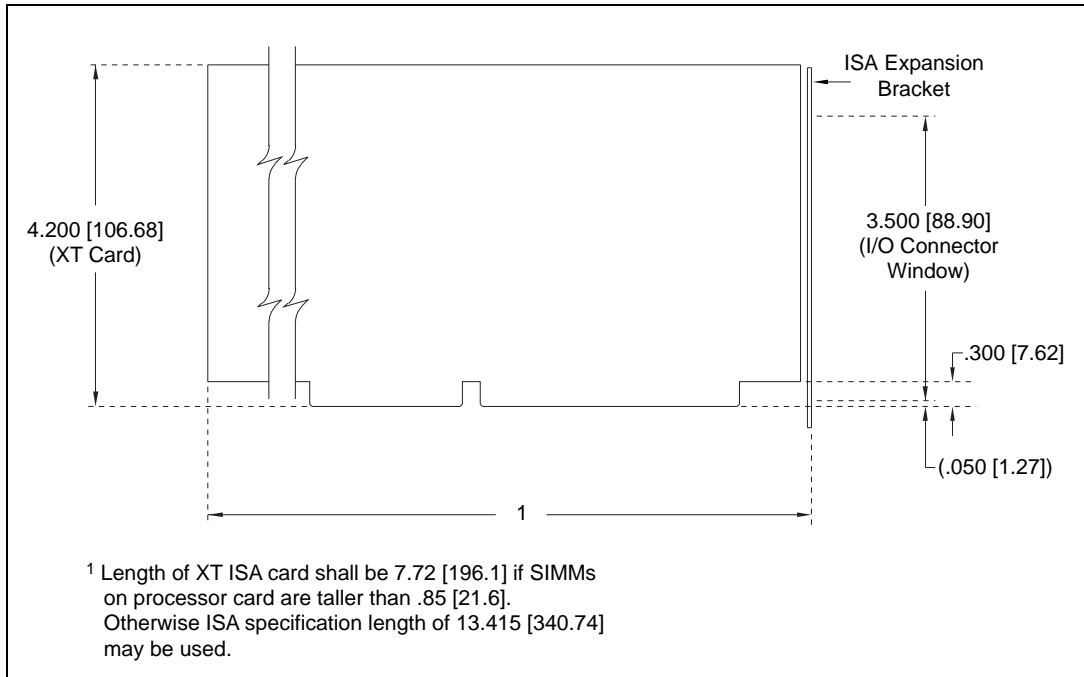
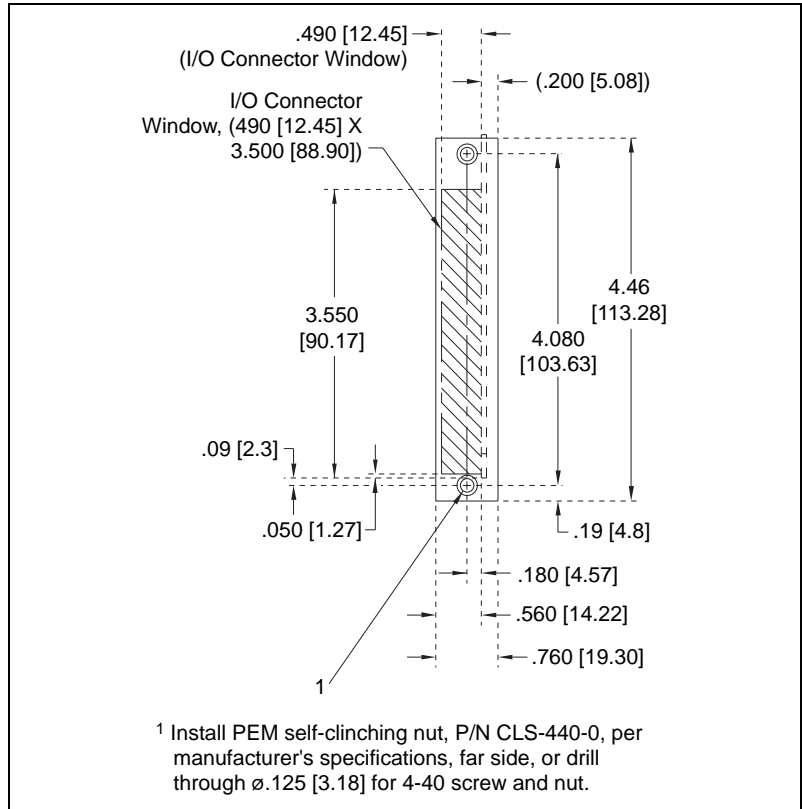

Figure E-10. Side View of ISA Board with Expansion Bracket



**Figure E-11.** Front View of ISA Board Expansion Bracket

# Common Questions

---

Appendix

**F**

This appendix answers common questions you may have when using the VXIpc 800 Series.

## **What do the LEDs on the front of the VXIpc 800 mean?**

Refer to Appendix C, *LED Indicators*, for a description of the front panel LEDs.

## **Is something wrong with the VXIpc 800 if the red SYSFAIL and FAILED LEDs stay lit after booting the VXIpc 800?**

If either the **SYSFAIL** or **FAILED** LED remains lit, refer to Appendix C, *LED Indicators*, for troubleshooting steps.

## **Can I access 32-bit registers in my VXIbus system from the VXIpc 800?**

Yes. The VXIpc 800 uses the 32-bit PCI bus to interface to the VXIbus. In fact, the VXIbus circuitry on the VXIpc 800 also supports the new VME64 standard for D64 accesses. Refer to your VXI software manual for more information.

## **What kind of signal is CLK10 and what kind of signal do I need for an external CLK10?**

CLK10 is a differential ECL signal on the backplane. However, the oscillator for the VXIpc 800 and the EXTCLK input on the VXIpc-800 front panel use TTL levels; therefore, you need to supply a TTL-level signal for EXTCLK. Our voltage converters convert the signal to differential ECL.

## **What is the accuracy of the CLK10 signal?**

The CLK10 signal generated by the VXIpc 800 is  $\pm 100$  ppm (0.01%) as per the VXIbus specification. If you need a more accurate CLK10 signal on the VXIpc 800 Series, you can use the EXTCLK connector on its front panel.

**If I boot the computer without video, and then plug in the video, why is it in black and white?**

When the computer first boots, the video chips try to synchronize with the monitor. If the monitor is not there, the video chips cannot synchronize and establish color. You need to have the monitor attached at boot time to get color.

**I've installed the SCSI software. Why doesn't the VXIpc 800 Series recognize my SCSI device?**

This problem usually occurs when SCSI has not been enabled in the BIOS. Enter your BIOS by pressing <DEL> at boot time. In the **Setup** window, click on the **Chipset** icon. Select the **On Board PCI SCSI** option and enable it.

**What type of video interface is onboard the VXIpc 800? What video drivers are included with the VXIpc 800? Can I use Super VGA with my VXIpc 800? If my application requires a special type of video display, how do I configure my VXIpc 800?**

The VXIpc 800 uses the Trident Microsystems TGUI96xx chip family, a combination graphics accelerator and RAMDAC. The TGUI9660 is the first chip used from this family. Subsequent pin-compatible chips will follow. The chips in this family are compatible with the Standard VGA video output MS Windows video driver, as well as the Trident Microsystems video driver. For more information on the video driver, refer to the `c:\images\manuals` directory.

If your application requires a special type of video display, you can remove the PCI video card included with your VXIpc 800 Series. Contact National Instruments for information on how to do this.

**What kind of monitor can I use with the VXIpc 800?**

VXIpc 800 computers that use Super VGA video output will work only with monitors having a horizontal scan rate of at least 50 kHz and a vertical scan rate of 60 Hz.



**Caution:** *Make sure that your monitor meets this specification. Enabling the Super VGA option on a monitor that does not meet this specification will cause damage to your monitor.*

**What if my keyboard connector does not fit into the keyboard port on the VXIpc 800?**

You can plug keyboards that have a 6-pin Mini DIN PS/2 type connector directly into the VXIpc 800. You can use the keyboard adapter cable that is included with every VXIpc 800 kit to adapt the larger AT keyboard connector to the 6-pin Mini DIN connector.

**How do I connect an external speaker to get audio capability?**

A twisted-pair cable connects the front panel audio connector to the VXIpc 800 Series motherboard. Connect the external speaker to this front-panel connector. The center pin of the connector provides the audio signal. The shield of the connector is GROUND.

**How do I add RAM to the VXIpc 800? What is the maximum amount of RAM that I can have on the VXIpc 800?**

For information about adding RAM to the VXIpc 800, refer to Appendix A, *Specifications*.

**Which interrupt levels are free to be used by ISA bus boards? Which area of upper memory (adapter space) is free for use by ISA bus boards or expanded memory manager software programs?**

See Appendix B, *VXIpc 800 Series System Resources*, for information on the available port I/O register space, upper memory area, interrupts, and DMA channels.

**How do I install the VXIpc 800 in a slot other than Slot 0?**

The VXIpc 800 automatically detects whether it is in Slot 0 of a VXIbus mainframe. You do not need to change jumper settings to install the VXIpc 800 in a slot other than Slot 0 unless you have defeated the first slot detector (FSD) circuitry by changing the appropriate jumper setting on the VXIpc 800.

Refer to either Chapter 3, *VXIpc 800 Series Configuration and Installation*, for information on enabling and defeating the FSD circuitry.

**How do I check the configuration of the memory, floppy drive, hard drive, time/date, and so on?**

You can view these parameters in the BIOS setup. To enter the BIOS setup, reboot the VXIpc 800 and press the <DEL> key during the memory tests. Refer to Chapter 4, *BIOS*, for more information.

**Can I upgrade my VXIpc 800?**

You can upgrade the modular CPU card to upgrade the processor. Contact National Instruments for information.

**How can I boot from an external SCSI hard drive?**

In the **Setup/Standard** window change the Master drive setting from **User** to **SCSI**, and make sure that SCSI is enabled in the **Setup/Chipset** window.

**Can I use the internal IDE drive and an external SCSI hard drive at the same time?**

Yes, but you can only boot from the internal IDE drive in this configuration.

**My CMOS is corrupted. How do I set it back to default?**

1. Select **Default/Optimal**.
2. Save and exit.

# Customer Communication

---

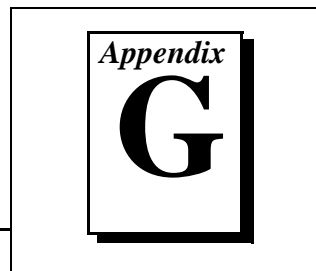

For your convenience, this appendix contains forms to help you gather the information necessary to help us solve your technical problems and a form you can use to comment on the product documentation. When you contact us, we need the information on the Technical Support Form and the configuration form, if your manual contains one, about your system configuration to answer your questions as quickly as possible.

National Instruments has technical assistance through electronic, fax, and telephone systems to quickly provide the information you need. Our electronic services include a bulletin board service, an FTP site, a fax-on-demand system, and e-mail support. If you have a hardware or software problem, first try the electronic support systems. If the information available on these systems does not answer your questions, we offer fax and telephone support through our technical support centers, which are staffed by applications engineers.

## Electronic Services



### Bulletin Board Support

National Instruments has BBS and FTP sites dedicated for 24-hour support with a collection of files and documents to answer most common customer questions. From these sites, you can also download the latest instrument drivers, updates, and example programs. For recorded instructions on how to use the bulletin board and FTP services and for BBS automated information, call (512) 795-6990. You can access these services at:

United States: (512) 794-5422

Up to 14,400 baud, 8 data bits, 1 stop bit, no parity

United Kingdom: 01635 551422

Up to 9,600 baud, 8 data bits, 1 stop bit, no parity

France: 01 48 65 15 59

Up to 9,600 baud, 8 data bits, 1 stop bit, no parity



### FTP Support

To access our FTP site, log on to our Internet host, `ftp.natinst.com`, as anonymous and use your Internet address, such as `joesmith@anywhere.com`, as your password. The support files and documents are located in the `/support` directories.



## Fax-on-Demand Support

Fax-on-Demand is a 24-hour information retrieval system containing a library of documents on a wide range of technical information. You can access Fax-on-Demand from a touch-tone telephone at (512) 418-1111.



## E-Mail Support (currently U.S. only)

You can submit technical support questions to the applications engineering team through e-mail at the Internet address listed below. Remember to include your name, address, and phone number so we can contact you with solutions and suggestions.

[support@natinst.com](mailto:support@natinst.com)

## Telephone and Fax Support

National Instruments has branch offices all over the world. Use the list below to find the technical support number for your country. If there is no National Instruments office in your country, contact the source from which you purchased your software to obtain support.



### Telephone



### Fax

Australia	03 9879 5166	03 9879 6277
Austria	0662 45 79 90 0	0662 45 79 90 19
Belgium	02 757 00 20	02 757 03 11
Brazil	011 288 3336	011 288 8528
Canada (Ontario)	905 785 0085	905 785 0086
Canada (Quebec)	514 694 8521	514 694 4399
Denmark	45 76 26 00	45 76 26 02
Finland	09 725 725 11	09 725 725 55
France	01 48 14 24 24	01 48 14 24 14
Germany	089 741 31 30	089 714 60 35
Hong Kong	2645 3186	2686 8505
Israel	03 6120092	03 6120095
Italy	02 413091	02 41309215
Japan	03 5472 2970	03 5472 2977
Korea	02 596 7456	02 596 7455
Mexico	5 520 2635	5 520 3282
Netherlands	0348 433466	0348 430673
Norway	32 84 84 00	32 84 86 00
Singapore	2265886	2265887
Spain	91 640 0085	91 640 0533
Sweden	08 730 49 70	08 730 43 70
Switzerland	056 200 51 51	056 200 51 55
Taiwan	02 377 1200	02 737 4644
United Kingdom	01635 523545	01635 523154
United States	512 795 8248	512 794 5678



# Technical Support Form

Photocopy this form and update it each time you make changes to your software or hardware, and use the completed copy of this form as a reference for your current configuration. Completing this form accurately before contacting National Instruments for technical support helps our applications engineers answer your questions more efficiently.

If you are using any National Instruments hardware or software products related to this problem, include the configuration forms from their user manuals. Include additional pages if necessary.

Name \_\_\_\_\_

Company \_\_\_\_\_

Address \_\_\_\_\_

\_\_\_\_\_

Fax (\_\_\_\_) \_\_\_\_\_ Phone (\_\_\_\_) \_\_\_\_\_

Computer brand \_\_\_\_\_ Model \_\_\_\_\_ Processor \_\_\_\_\_

Operating system (include version number) \_\_\_\_\_

Clock speed \_\_\_\_\_MHz RAM \_\_\_\_\_MB Display adapter \_\_\_\_\_

Mouse \_\_\_yes \_\_\_no Other adapters installed \_\_\_\_\_

Hard disk capacity \_\_\_\_\_MB Brand \_\_\_\_\_

Instruments used \_\_\_\_\_

\_\_\_\_\_

National Instruments hardware product model \_\_\_\_\_ Revision \_\_\_\_\_

Configuration \_\_\_\_\_

National Instruments software product \_\_\_\_\_ Version \_\_\_\_\_

Configuration \_\_\_\_\_

The problem is: \_\_\_\_\_

\_\_\_\_\_

\_\_\_\_\_

\_\_\_\_\_

List any error messages: \_\_\_\_\_

\_\_\_\_\_

\_\_\_\_\_

The following steps reproduce the problem: \_\_\_\_\_

\_\_\_\_\_

\_\_\_\_\_

\_\_\_\_\_

\_\_\_\_\_

\_\_\_\_\_

# Hardware and Software Configuration Form

Record the settings and revisions of your hardware and software on the line to the right of each item. Complete a new copy of this form each time you revise your software or hardware configuration, and use this form as a reference for your current configuration. Completing this form accurately before contacting National Instruments for technical support helps our applications engineers answer your questions more efficiently.

## National Instruments Products

### VXIpc 800 Series Hardware Settings

VXIpc 800 Series Model Number \_\_\_\_\_

VXIpc 800 Series Part Number \_\_\_\_\_

VXIpc 800 Series Serial Number \_\_\_\_\_

Processor Speed \_\_\_\_\_

DRAM SIMMs Installed \_\_\_\_\_

Hard Drive Size \_\_\_\_\_ Video Memory \_\_\_\_\_

Slot Location \_\_\_\_\_

W1 Setting: SCSI Termination \_\_\_\_\_

W2 Setting: CMOS \_\_\_\_\_

W4 Setting: LPT1 DMA \_\_\_\_\_

W13 Setting: Slot 0 Detection \_\_\_\_\_

S1 Setting: Ethernet EEPROM \_\_\_\_\_

S2 Setting: MITE Self-Configuration \_\_\_\_\_

S3 Setting: CLK10 Source \_\_\_\_\_

S4 Setting: Inverted/Non-inverted CLK10 Output \_\_\_\_\_

S5 Setting: CLK10 SMB \_\_\_\_\_

S6 Setting: CLK10 Input Termination \_\_\_\_\_

S7 Setting: External Trigger Input Termination \_\_\_\_\_

S8 Setting: GPIB IRQ Level \_\_\_\_\_

S9 Setting: MITE User/Factory Configuration \_\_\_\_\_

## Other Products

Mainframe make and model \_\_\_\_\_

Microprocessor \_\_\_\_\_

Clock frequency or speed \_\_\_\_\_

Type of video board installed \_\_\_\_\_

Operating system and version \_\_\_\_\_

Operating system mode \_\_\_\_\_

Programming language \_\_\_\_\_

Programming language version \_\_\_\_\_

Other boards in system \_\_\_\_\_

Monitor (manufacturer, model) \_\_\_\_\_

Mouse (manufacturer, model) \_\_\_\_\_

Keyboard (manufacturer, model) \_\_\_\_\_

Other peripherals (manufacturer, model) \_\_\_\_\_

\_\_\_\_\_

\_\_\_\_\_

\_\_\_\_\_

# Documentation Comment Form

National Instruments encourages you to comment on the documentation supplied with our products. This information helps us provide quality products to meet your needs.

**Title:** *VXIpc™ 800 Series User Manual*

**Edition Date:** September 1997

**Part Number:** 321744A-01

Please comment on the completeness, clarity, and organization of the manual.

---

---

---

---

---

---

---

---

If you find errors in the manual, please record the page numbers and describe the errors.

---

---

---

---

---

---

---

---

Thank you for your help.

Name \_\_\_\_\_

Title \_\_\_\_\_

Company \_\_\_\_\_

Address \_\_\_\_\_

\_\_\_\_\_

Phone (\_\_\_\_) \_\_\_\_\_ Fax (\_\_\_\_) \_\_\_\_\_

**Mail to:** Technical Publications  
National Instruments Corporation  
6504 Bridge Point Parkway  
Austin, TX 78730-5039

**Fax to:** Technical Publications  
National Instruments Corporation  
(512) 794-5678

<b>Prefix</b>	<b>Meaning</b>	<b>Value</b>
n-	nano-	$10^{-9}$
$\mu$ -	micro-	$10^{-6}$
m-	milli-	$10^{-3}$
k-	kilo-	$10^3$
M-	mega-	$10^6$
G-	giga-	$10^9$

## **A**

<b>A</b>	Amperes
address	Character code that identifies a specific location (or series of locations) in memory
address space	A set of $2^n$ memory locations differentiated from other such sets in VXI/VMEbus systems by six addressing lines known as address modifiers. $n$ is the number of address lines required to uniquely specify a byte location in a given space. Valid numbers for $n$ are 16, 24, and 32. In VME/VXI, because there are six address modifiers, there are 64 possible address spaces.
ANSI	American National Standards Institute
ASIC	application-specific integrated circuit

## B

b	bits
B	bytes
backplane	An assembly, typically a printed circuit board, with 96-pin connectors and signal paths that bus the connector pins. A C-size VXIbus system will have two sets of bused connectors called J1 and J2. A D-size VXIbus system will have three sets of bused connectors called J1, J2, and J3.
BERR*	Bus error signal
BIOS	Basic Input/Output System. BIOS functions are the fundamental level of any PC or compatible computer. BIOS functions embody the basic operations needed for successful use of the computer's hardware resources.
bus error	An error that signals failed access to an address. Bus errors occur with low-level accesses to memory and usually involve hardware with bus mapping capabilities. For example, nonexistent memory, a nonexistent register, or an incorrect device access can cause a bus error.

## C

CLK10	A 10 MHz, $\pm 100$ ppm, individually buffered (to each module slot), differential ECL system clock that is sourced from Slot 0 of a VXIbus mainframe and distributed to Slots 1 through 12 on P2. It is distributed to each slot as a single-source, single-destination signal with a matched delay of under 8 ns.
CMOS	Complementary Metal Oxide Semiconductor; a process used in making chips

## D

DIN	Deutsches Institut für Normung—German Standards Institute
DMA	Direct Memory Access; a method by which data is transferred between devices and internal memory without intervention of the central processing unit

**DRAM** Dynamic RAM (Random Access Memory); storage that the computer must refresh at frequent intervals

## **E**

**ECL** Emitter-Coupled Logic

**EDO** Extended Data Out; a DRAM architecture that shortens overall access latency, improving performance

**EEPROM** Electronically Erasable Programmable Read Only Memory

**embedded controller** An intelligent CPU (controller) interface plugged directly into the VXI backplane, giving it direct access to the VXIbus. It must have all of its required VXI interface capabilities built in.

**EMC** Electromagnetic Compliance

## **F**

**fair requester** A VXIbus device that will not arbitrate for the VXIbus after releasing it until it detects the bus request signal inactive. This ensures that all requesting devices will be granted use of the bus.

**FPERR** Floating Point Error

## **G**

**GPIB** General Purpose Interface Bus (IEEE 488)

## **H**

**hex** hexadecimal; the numbering system with base 16, using the digits 0 to 9 and letters A to F

**Hz** hertz; cycles per second

## I

IDE	Integrated Drive Electronics. Denotes the most common interface to the hard drive on PCs.
IEEE	Institute of Electrical and Electronics Engineers
in.	inches
I/O	input/output; the techniques, media, and devices used to achieve communication between machines and users
instrument driver	A set of routines designed to control a specific instrument or family of instruments, and any necessary related files for LabWindows/CVI or LabVIEW
INT	interrupt
INTA	PCI interrupt A
INTB	PCI interrupt B
INTC	PCI interrupt C
INTD	PCI interrupt D
interrupt	A means for a device to request service from another device
interrupt handler	A VMEbus functional module that detects interrupt requests generated by interrupters and responds to those requests by requesting status and identify information
interrupt level	The relative priority at which a device can interrupt
IRQ*	Interrupt signal
ISA	Industry Standard Architecture denotes a common expansion bus used in PCs

## K

KB	kilobytes of memory
----	---------------------



**L**

LED Light-emitting diode

**M**

m meters

master A functional part of a VME/VXIbus device that initiates data transfers on the backplane. A transfer can be either a read or a write.

MB megabytes of memory

MITE A National Instruments custom ASIC, a sophisticated dual-channel DMA controller that incorporates the Synchronous MXI and VME64 protocols to achieve high-performance block transfer rates

MODID Module ID Lines. Used in VXI to geographically locate boards and to dynamically configure boards

MTBF Mean Time Between Failure

**N**

NI-VISA The National Instruments implementation of the VISA standard; an interface-independent software that provides a unified programming interface for VXI, GPIB, and serial instruments

NI-VXI The National Instruments bus interface software for VME/VXIbus systems

NMI NonMaskable Interrupt

Non-Slot 0 device A device configured for installation in any slot in a VXIbus mainframe other than Slot 0. Installing such a device into Slot 0 can damage the device, the VXIbus backplane, or both.

## P

PCI	Peripheral Component Interconnect. The PCI bus is a high-performance 32-bit or 64-bit bus with multiplexed address and data lines.
PCMCIA	Personal Computer Memory Card International Association
PEM	Penn Engineering Manufacturing Corporation. A manufacturer of nuts pressed into metal
POSC	Power-On Self Configuration. A process by which the MITE chip programs its own registers from EEPROMs at power up
PWB	Printed Wire Board

## R

Resource Manager	A message-based Commander located at Logical Address 0, which provides configuration management services such as address map configuration, Commander and Servant mappings, and self-test and diagnostic management
------------------	---

## S

s	seconds
SCSI	Small Computer System Interface
SIMM	Single In-line Memory Module
slave	A functional part of a VME/VXibus device that detects data transfer cycles initiated by a VMEbus master and responds to the transfers when the address specifies one of the device's registers
Slot 0 device	A device configured for installation in Slot 0 of a VXibus mainframe. This device is unique in the VXibus system in that it performs the VMEbus System Controller functions, including clock sourcing and arbitration for data transfers across the backplane. Installing such a device into any other slot can damage the device, the VXibus backplane, or both.
SMB	Sub Miniature Type B connector that features a snap coupling for fast connection

**T**

trigger Either TTL or ECL lines used for intermodule communication

TTL Transistor-Transistor Logic

**V**

V Volts

VISA Virtual Instrument Software Architecture. This is the general name given to VISA and its associated architecture.

VME Versa Module Eurocard or IEEE 1014

VMEbus System Controller A device configured for installation in Slot 0 of a VXIbus mainframe or Slot 1 of a VMEbus chassis. This device is unique in the VMEbus system in that it performs the VMEbus System Controller functions, including clock sourcing and arbitration for data transfers across the backplane. Installing such a device into any other slot can damage the device, the VMEbus/VXIbus backplane, or both.

VXIbus VMEbus Extensions for Instrumentation

## A

ACCESS LED, 1-7, C-3  
address map, I/O (table), B-3 to B-4  
application-specific interface chips, custom, 1-5  
audio capability. *See* speaker.

## B

BIOS. *See also* CMOS.  
clearing CMOS contents, 3-12  
entering setup, 4-1  
viewing settings, F-4  
board access LEDs, C-3  
bulletin board support, G-1

## C

CLK10 signal, VXIbus  
accuracy, F-1  
definition, F-1  
routing, 3-5 to 3-7  
selecting signal source (figure), 3-6  
SMB CLK10 direction (figure), 3-6  
SMB CLK10 polarity (figure), 3-7  
SMB CLK10 termination (figure), 3-7  
CMOS. *See also* BIOS.  
PC configuration, 3-12  
setting back to default, F-4  
COM1 and COM2 connectors and signals,  
D-6 to D-7  
common questions about VXIpc 800 Series,  
F-1 to F-4

## configuration

default settings, 3-1 to 3-3  
factory default settings (table), 3-3  
parts locator diagram, 3-2  
EEPROM, 3-8 to 3-10  
configuration settings (figure), 3-9  
fixing invalid configuration,  
3-9 to 3-10  
power-on self configuration status  
(figure), 3-8  
protecting against electrical hazards  
(warning), 3-10

electrostatic discharge (warning), 3-1  
installed system RAM, 3-10  
installing VXIpc-800 Series, 3-13 to 3-14  
PC configuration, 3-10 to 3-13  
Ethernet power-on defaults, 3-13  
GPIB interrupt level, 3-11  
parallel port DMA level, 3-12  
SCSI termination, 3-11  
system CMOS, 3-12

removing metal enclosure, 3-4  
trigger input termination, 3-8  
VXIbus CLK10 routing, 3-5 to 3-7  
VXIbus Slot 0/non-Slot 0, 3-4 to 3-5

## connectors

COM1 and COM2, D-6 to D-7  
Ethernet, D-5 to D-6  
external SMBs, D-14  
front panel connectors, 1-6  
front panel connectors (table), D-1E-1  
GPIB (IEEE-488.2), D-12 to D-13  
keyboard and mouse, D-3  
parallel port, D-8 to D-9

- SCSI, D-10 to D-11
- signal characteristics, D-16
- speaker, D-15
- VGA, D-4 to D-5
- VXIbus P1 and P2, D-17 to D-20
- CPU card, 2-4
- custom application-specific interface chips, 1-5
- customer communication, *xii*, G-1 to G-2

## D

- default settings, 3-1 to 3-3
  - factory default settings (table), 3-3
  - parts locator diagram, 3-2
- disk drives. *See* IDE controller; SCSI interface.
- DMA channel
  - level for parallel port, PC configuration, 3-12
  - resource allocations (table), B-2
- documentation
  - conventions used in manual, *x-xi*
  - how to use documentation set, *xi-xii*
  - organization of manual, *ix-x*
  - related documentation, *xii*
- DRIVE LED, 1-7, C-3
- DSEL LED, 1-7, C-4

## E

- EEPROM configuration, 3- to 3-10
  - configuration settings (figure), 3-9
  - fixing invalid configuration, 3-9 to 3-10
  - power-on self configuration status (figure), 3-8
  - protecting against electrical hazards (warning), 3-10
- electrical specifications, A-1 to A-2
- electronic support services, G-1 to G-2
- e-mail support, G-2

- environmental specifications, A-3
- equipment, optional, 1-3
- Ethernet
  - connector and signals, D-5 to D-6
  - LEDs for status, 1-7, C-3 to C-4
  - overview, 2-3
  - power-on defaults, PC configuration VXIpc 800 Series, 3-13
- expansion boards. *See* I/O expansion boards.

## F

- FAILED LED, 1-6, C-1
- fax and telephone support, G-2
- Fax-on-Demand support, G-2
- front panel. *See also* connectors; LEDs on front panel.
  - features, 1-6
  - layout and dimensions (figure), D-2
- FTP support, G-1

## G

- GPIB (IEEE 488.2)
  - connectors and signals, D-12 to D-13
  - overview, 2-3
  - PC configuration interrupt level, 3-11

## H

- hard disk. *See* IDE controller; SCSI interface.
- hardware description, 1-4 to 1-8
  - custom application-specific interface chips, 1-5
  - front panel features, 1-6
  - models available, 1-4
  - peripheral expansion, 1-7
  - peripherals overview (table), 1-8
  - Slot 0 functionality, 1-4

**I**

- IDE controller
  - overview, E-3
  - problems with booting hard disk, F-4
  - using internal IDE drive and external SCSI hard drive, F-4
- installation. *See also* configuration.
  - electrostatic discharge (warning), 3-1, 3-13
  - installation procedure, 3-13 to 3-14
  - I/O expansion boards, E-7 to E-11
  - Slot 0 detection (warning), 3-13
- interrupts
  - GPIB interrupt level, PC configuration, 3-11
  - ISA interrupt resource allocations (table), B-1 to B-2
  - PCI, B-1
- I/O address map (table), B-3 to B-4
- I/O expansion boards
  - installation
    - materials needed, E-7
    - procedure, E-7 to E-11
  - overview, 1-7
  - peripherals overview (table), 1-8
  - VXIpc-850 plug-in boards
    - height, E-1
    - length of ISA plug-in boards, E-3
    - length of PCI plug-in boards, E-2
  - VXIpc-860 plug-in boards
    - height, E-4
    - length of ISA plug-in boards, E-6
    - length of PCI plug-in boards, E-5
- ISA expansion slot, 2-4
- ISA interrupt resource allocations (table), B-1 to B-2
- ISA plug-in boards, length of
  - VXIpc-850 plug-in boards, E-3
  - VXIpc-860 plug-in boards, E-6

**J**

- jumper settings, 3-3. *See also* configuration.

**K**

- keyboard connector
  - location and pinout (figure), D-3
  - problems with plugging in keyboards, F-3
  - signals (table), D-3

**L**

- LabVIEW software, 1-3 to 1-4
- LabWindows/CVI software, 1-3 to 1-4
- LEDs on front panel
  - board access LEDs, C-3
  - common questions and answers, F-1
  - Ethernet LEDs, 1-7, C-3 to C-4
  - system startup cycle, C-2 to C-3
  - VXI and PC status LEDs, 1-6 to 1-7
  - VXIbus interface status LEDs, C-1 to C-4
- LINK LED, 1-7, C-4

**M**

- MANTIS custom ASIC, 1-5, 2-3
- manual. *See* documentation.
- memory. *See* RAM.
- MITE custom ASIC, 1-5, 2-3
- monitor. *See also* video interface.
  - booting for color, F-2
  - type to use with VXIpc-850, F-2
- mouse connector, D-3

**N**

- NI-488.2 software kit, 1-3
- NI-VXI bus software, 1-3

**O**

ONLINE LED, 1-6, C-1

**P**

parallel port

- connector and signals, D-8 to D-9
- DMA level, PC configuration, 3-12

PC configuration, 3-10 to 3-13

- Ethernet power-on defaults, 3-13
- GPIB interrupt level, 3-11
- parallel port DMA level, 3-12
- SCSI termination, 3-11
- system CMOS, 3-12

PCI expansion slot, 2-4

PCI interrupts, B-1

PCI plug-in boards, length of

- VXIpc-850 plug-in boards, E-2
- VXIpc-860 plug-in boards, E-5

PCMCIA interface, 2-3

peripheral expansion. *See* I/O expansion boards.

peripherals overview (table), 1-8

physical specifications, A-2

plug-in boards. *See* I/O expansion boards.

**Q**

questions and answers about VXIpc 800 Series, F-1 to F-4

**R**

RAM

- adding RAM, A-5
- installed system RAM, 3-10

RX LED, 1-7, C-3

**S**

SCSI interface

- common questions and answers, F-2, F-4
- connector and signals, D-10 to D-11
- overview, 2-4
- setting up in BIOS, F-2
- termination, PC configuration, 3-11

serial port connectors and signals, D-6 to D-7

signals

- COM1 and COM2 connectors (table), D-7

- Ethernet connector (table), D-6

- GPIB (IEEE 488.2) (table), D-13

- keyboard connector (table), D-3

- parallel port (table), D-9

- SCSI interface (table), D-11

SMBs

- characteristics (table), D-16
- connector signals (table), D-14
- speaker characteristics (table), D-16
- VGA connector (table), D-4 to D-5
- VXIbus P1 and P2 (table), D-17 to D-20

Slot 0 functionality

- configuration as Slot 0 or non-Slot 0, 3-4 to 3-5, F-3

- installation of VXIpc-800 (warning), 3-13
- overview, 1-4

SMB

- connector location and pinout (figure), D-14

signals

- characteristics (table), D-16
- connector signals (table), D-14

- SMB CLK10 direction (figure), 3-6

- SMB CLK10 polarity (figure), 3-7

- SMB CLK10 termination (figure), 3-7

- trigger input termination (figure), 3-8

software, optional, 1-3 to 1-4

speaker

- connecting external speaker to VXIpc 800 Series, F-3
- connector location (figure), D-15
- signal characteristics (table), D-16

specifications

- adding RAM, A-5
- electrical, A-1 to A-2
- environmental, A-3
- physical, A-2
- requirements, A-1
- VMEbus capability codes, A-3 to A-4

switch settings, 3-3. *See also* configuration.

SYSFAIL LED, 1-6, C-1

system CMOS, PC configuration, 3-12

system I/O, 2-4

system resources

- DMA channel resource allocations, B-2
- I/O address map, B-3 to B-4
- ISA interrupt resource allocations (table), B-1 to B-2
- PCI interrupts, B-1
- resource tables, B-1 to B-4

system startup cycle and LEDs, C-2 to C-3

## T

technical support, G-1 to G-2

terminal. *See* monitor.

TEST LED, 1-6, C-1

TNT4882C custom ASIC, 1-4

trigger input termination, 3-8

troubleshooting problems, F-1 to F-4

TX LED, 1-7, C-3

## V

VGA connector, D-4 to D-5

video interface. *See also* monitor.

- common questions and answers, F-2
- overview, 2-3
- VGA connector, D-4 to D-5

VMEbus capability codes, A-3 to A-4

VXIbus

- accessing 32-bit registers, F-1
- CLK10 routing, 3-5 to 3-7
- interface circuitry, 2-3
- interface status LEDs, C-1 to C-3
- P1 and P2 connectors and signals, D-17 to D-20
- Slot 0 functionality
  - configuration, 3-4 to 3-5
  - overview, 1-4
  - questions and answers, F-3

VXIpc 800 Series

- block diagrams, 2-2
- functional description, 2-1 to 2-4
- hardware description, 1-4 to 1-8
  - custom application-specific interface chips, 1-5
  - front panel features, 1-6
  - models available, 1-4
  - peripheral expansion, 1-7
  - peripherals overview (table), 1-8
  - Slot 0 functionality, 1-4
- logic blocks, 2-3 to 2-4
- optional equipment, 1-3
- optional software, 1-3 to 1-4
- overview, 1-1 to 1-2
- upgrading, F-4
- VIXpc-850 embedded computers (figure), 1-1
- VXIpc-860 embedded computer (figure), 1-2

VXIplug&play compliance, 1-2, D-1